

VTX

DIVE COMPUTER

OPERATING MANUAL

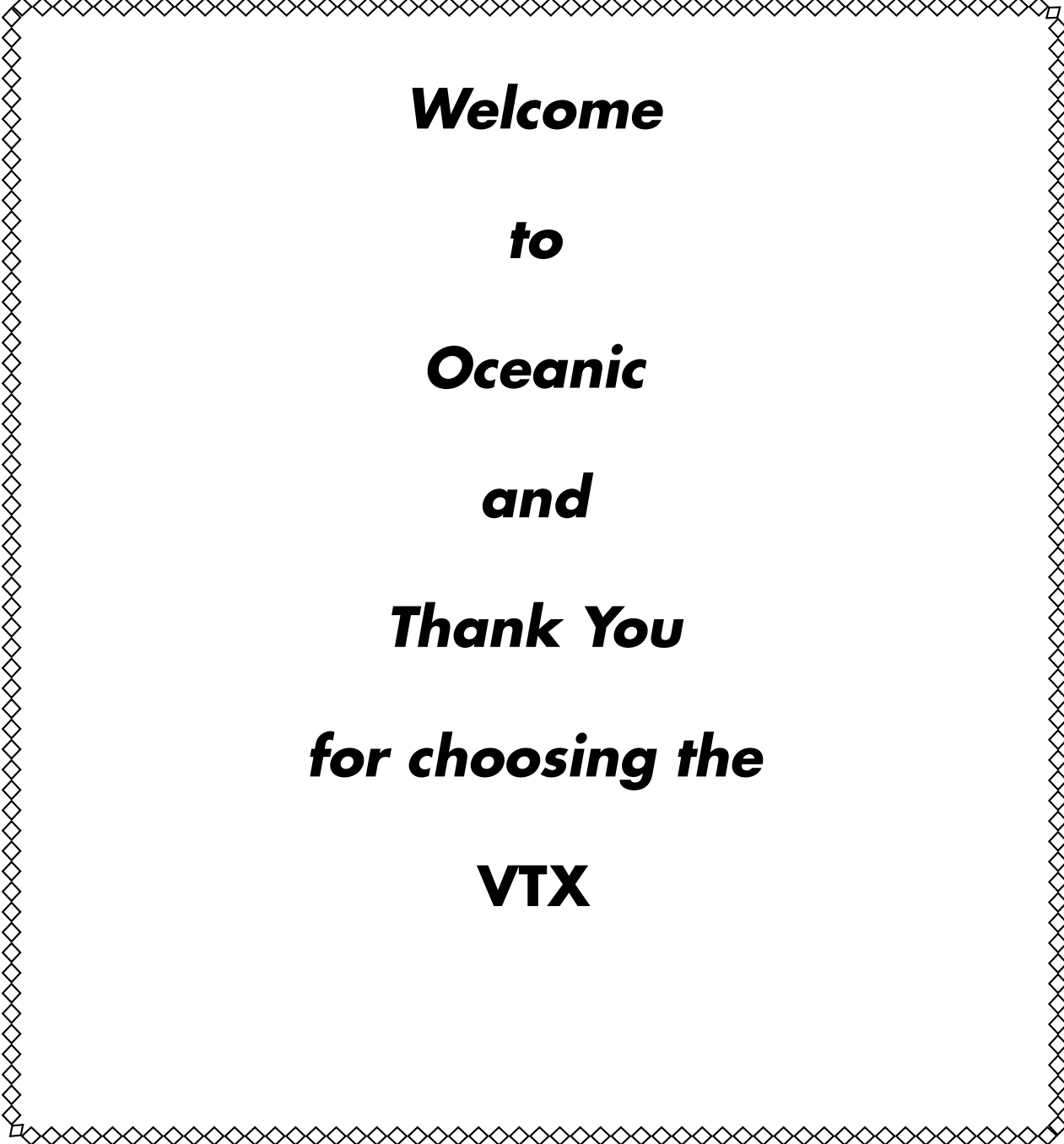

Welcome
to
Oceanic
and
Thank You
for choosing the
VTX

CONTENTS

NOTICES.....	4	GAS/TMT SWITCHING.....	32
ACTIVATION AND OVERVIEW.....	5	OVERVIEW.....	33
ACTIVATION.....	6	NORM GAS SWITCH MENU.....	33
MENU SYSTEM.....	6	GAUG TMT SWITCH MENU.....	33
SAMPLE DISPLAYS, ICONS, ABBREVIATIONS.....	7	GAUG OP MODE.....	34
POWER SUPPLY.....	8	GAUG SURF MAIN.....	35
Power Saver Mode.....	8	ADJUST BRIGHTNESS.....	35
VTX BATTERY STATUS.....	8	GAUG SURF ALTS.....	35
Low Battery Warning, Alarm.....	8	GAUG MENU.....	35
TRANSMITTER (TMT) BATTERY STATUS.....	8	Set Alarms Menu.....	36
BRIGHTNESS CONTROL.....	9	Set Utilities Menu.....	36
Adjust Brightness.....	9	View Preview.....	36
AUDIBLE ALARM.....	9	GAUG DIVE MAIN.....	37
OPERATING MODES.....	10	Adjust Brightness.....	37
HOME MODE.....	11	GAUG Dive ALT.....	37
HOME MENU.....	12	Delayed Violation.....	37
My Info.....	12	FREE DIVE OP MODE.....	38
DC Info.....	12	FREE SURF MAIN.....	39
Clear NI-O2 Calculations.....	12	ADJUST BRIGHTNESS.....	39
Home Setup Menu.....	13	FREE SURF ALTS.....	39
Set Auto Dim.....	13	FREE MENU.....	40
Set Date, Time Menu.....	13	Countdown Timer.....	40
Battery/TMT Status.....	13	Set Menu.....	40
Bluetooth.....	14	FREE DIVE MAIN.....	41
NORM/GAUG Log Mode.....	15	Adjust Brightness.....	41
NORM/GAUG History Mode.....	15	FREE Dive ALT.....	41
NORM SURFACE MODE.....	16	FREE DIVE ALARMS.....	41
NORM SURF MAIN.....	17	COMPASS MODE.....	43
ADJUST BRIGHTNESS.....	17	COMPONENTS.....	44
NORM SURF ALTS.....	17	OVERVIEW.....	45
NORM MENU.....	18	COMPASS MENU.....	45
Plan Mode.....	18	NORTH OP MAIN.....	45
Set Gas Menu.....	18	REFERENCE OP MAIN.....	45
Set TMT Menu (NORM, GAUG).....	19	REFERENCE MENU.....	46
Set Alarms Menu.....	20	CALIBRATION.....	46
Set Utilities Menu.....	20	DECLINATION.....	47
Set Preview.....	20	ALARMS.....	47
View Preview.....	21	NORM/GAUG DIVE MODE ALARMS.....	48
DIVE MODE FEATURES.....	21	REFERENCE.....	51
TRANSMITTER SIGNAL RECEPTION GUIDE.....	23	UPLOADING/DOWNLOADING.....	52
PROXIMITY OF THE TMTS AND VTX.....	23	USB Connection.....	52
Link Interruption Underwater.....	23	PC/Mac Requirements.....	52
OVERVIEW OF AUTO DIM.....	23	ALTITUDE SENSING AND ADJUSTMENT.....	53
WET ACTIVATION.....	24	CARE AND CLEANING.....	53
BAR GRAPHS.....	24	INSPECTIONS AND SERVICE.....	53
ALGORITHM.....	24	BATTERY REPLACEMENT.....	54
CONSERVATIVE FACTOR.....	24	Data Retention.....	54
DEEP STOP.....	24	TRANSMITTER BATTERY REPLACEMENT.....	55
SAFETY STOP.....	25	TRANSMITTER INSTALLATION ON A REGULATOR.....	55
DIVE TIME REMAINING (DTR).....	25	TECHNICAL DATA.....	56
No Deco DTR (NDC).....	25	SPECIFICATIONS.....	57
O2 DTR (OTR).....	25	DSAT ALGORITHM NDL CHART.....	60
GAS TIME REMAINING (GTR).....	25	ALTITUDE LEVEL CHART.....	60
NORM DIVE MODES.....	26	Z+ ALGORITHM NDL CHART.....	61
NO DECO MAIN.....	27	ADDITIONAL INFORMATION - BRIGHTNESS & POWER.....	62
ADJUST BRIGHTNESS.....	27	INSPECTION/SERVICE RECORD.....	63
NO DECO ALT.....	27	OCEANIC WORLDWIDE.....	63
DEEP STOP (DS).....	27		
SAFETY STOP (SS).....	28		
DECOMPRESSION.....	28		
VIOLATION MODES.....	29		
HIGH PO2.....	30		
HIGH O2.....	31		

NOTICES

LIMITED TWO-YEAR WARRANTY

For details, refer to the Product Warranty Registration Card provided. Register on line at www.oceanicworldwide.com

COPYRIGHT NOTICE

This operating manual is copyrighted, all rights are reserved. It may not, in whole or in part, be copied, photocopied, reproduced, translated, or reduced to any electronic medium or machine readable form without prior consent in writing from Oceanic/2002 Design.

VTX Operating Manual, Doc. No. 12-5382
© 2002 Design, 2014
San Leandro, CA USA 94577

TRADEMARK, TRADE NAME, AND SERVICE MARK NOTICE

Oceanic, the Oceanic logo type, VTX, the VTX logo, GasTime Remaining (GTR), Diver Replaceable Batteries, Graphic Diver Interface, Tissue Loading Bar Graph (TLBG), Pre Dive Planning Sequence (PDPS), Set Point, Control Console, Turn Gas Alarm, and Dual Algorithm are all registered and unregistered trademarks, trade names, and service marks of Oceanic. All rights are reserved.

PATENT NOTICE

U.S. Patents have been issued, or applied for, to protect the following design features:

Dive Computer with Free Dive Mode and Wireless Data Transmission (U.S. Patent no. 7,797,124), Dive Computer with Free Dive Mode (U.S. Patent no. 8,600,701), and Air Time Remaining (U.S. Patent no. 6,543,444). Other patents pending. User Setable Display (U.S. Patent no. 5,845,235) is owned by Suunto Oy Finland.

DECOMPRESSION MODEL

The programs within the VTX simulate the absorption of nitrogen into the body by using a mathematical model. This model is merely a way to apply a limited set of data to a large range of experiences. The VTX dive computer model is based upon the latest research and experiments in decompression theory. **Still, using the VTX, just as using the U.S. Navy (or other) No Decompression Tables, is no guarantee of avoiding decompression sickness, i.e. "the bends."** Every diver's physiology is different, and can even vary from day to day. No machine can predict how your body will react to a particular dive profile.

FCC ID: MH8A

FCC COMPLIANCE:

This equipment complies with Part 15 of the FCC Rules. Operation is subject to the following two conditions: 1.) this equipment may not cause harmful interference, and 2.) this equipment must accept any interference received, including interference that may cause undesired operation.

FCC INTERFERENCE STATEMENT:

This equipment has been tested and found to comply with the limits for an Intentional Radiator, a Class B Digital Device, pursuant to Part 15 of FCC Rules, Title 47 of the Code of Federal Regulations. These rules are designed to provide reasonable protection against harmful interference in a commercial or residential installation. This equipment generates, uses and can radiate radio frequency energy and, if not installed and used in accordance with the instructions, may cause harmful interference to radio communications.

There is no guarantee that interference will not occur in a particular installation. If this equipment does cause interference to radio or television reception, which can be determined by turning the equipment off and on, the user is encouraged to try to correct the interference by one or more of the following measures:

- Reorient or relocate the receiving antenna.
- Increase the separation between the equipment and receiver.
- Connect the equipment to an outlet on a circuit different from that to which the receiver is connected.
- Consult the dealer or an experienced radio/TV technician.

⚠ Warning: Changes or modifications to this unit not expressly approved by Oceanic/2002 Design could void the user's authority to operate the equipment.



Pay special attention to items marked with this Warning symbol.

ACTIVATION AND OVERVIEW

INTERACTIVE CONTROL CONSOLE

The interactive control console utilizes 3 control buttons that are referred to as M, A, and S (Fig. 1).

- M (left front) - Menu, Mode, Minus (decrease)
- A (right front) - Advance, Add (increase).
- S (right side) - Select, Save.



Fig. 1 - Control Buttons

ACTIVATION

To activate the VTX, press/release any button.

- An Oceanic welcome screen will be displayed for 3 seconds (Fig. 2)* during which diagnostics will be performed verifying that sensors and battery voltage are within tolerance.

**After the Battery is replaced on a new day prior to performing any dives, a message is displayed before the welcome.*

- It will also check ambient barometric pressure, and calibrate present depth as 0. When at 3001 feet (916 meters), or higher, it will adjust depth for the higher altitude.
- After the diagnostic check, the Home Menu screen will be displayed (Fig. 3) allowing you to select what you would like to do (view information, perform setup, access operating modes).
- If no button is pressed within 2 minutes, the unit will enter PSM (Power Saver Mode) turning the screen off. Refer to page 8.
- If no dive is made within 2 hours, the unit will shut Off.



Fig. 2 - Diagnostic Check (for 3 sec, then Home Menu)

Wet activation contacts will automatically activate the unit and cause it to enter dive mode when the contacts become wet and it senses depth of 5 FT (1.5 M). They will not inadvertently activate Surface Mode such as when in a wet gear bag.

MENU SYSTEM

The viewing area is used to display alpha numeric messages and measured values as well as menu type systems for selection of settings and various auxiliary functions. It also serves as the Digital Compass.

Menus which are identified by function such as Main, Set, and Switch. The items available within the menus vary according to the mode you are in at the time. Some settings, such as for Units, are common throughout the modes and can be changed in any Utilities Menu.



Fig. 2A - Message given after Battery Change on new day

- Home Menu
 - >> Home Setup Menu
 - >> Set Date Time Menu
- NORM Surface Main Menu
 - >> Set Gas Menu
 - >> Set TMTs Menu
 - >> Set Alarms Menu
 - >> Set Utilities Menu
 - >> Set Preview Menu
- NORM Dive Menu
 - >> Gas/TMT Switch Menu
- GAUG Surface Main Menu
 - >> Set TMTs Menu
 - >> Set Alarms Menu
 - >> Set Utilities Menu
- GAUG Dive Menu
 - >> TMT Switch Menu
- FREE Surface Main Menu
 - >> Set Menu
- Compass Surface Menu
 - >> Reference Menu
 - >> Set Declination Menu
- Compass Dive Menu
 - >> Reference Menu

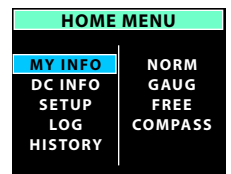

Fig. 3 - Home Menu (after Diagnostics)

Upon entering a menu, movement through it starts at the first (top) selection, then continues in a rolling manner down the screen. Items or selections are generally shown in columns of up to 7 items. Additional items form a second column (Fig. 4).

Typical button operations within menu systems >>

- A (< 2 sec) - to step down the screen (forward) through selections.
- M (< 2 sec) - to step up the screen (backward) through selections.
- S (< 2 sec) - to select or access the item highlighted.
- S (2 sec) - to step back to the menu after the item is selected.
- M (2 sec) anytime, or no button action for 2 minutes - will revert to Home or the Surface Main.

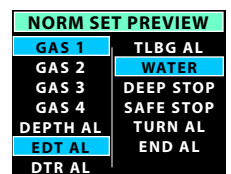
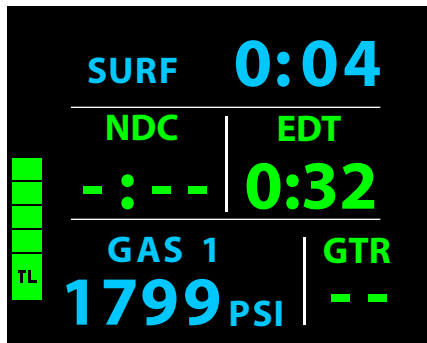

Fig. 4 - Sample Menu (13 items, 2 columns)

SAMPLE DISPLAY LAYOUTS

SURFACE MAIN



SET MENU

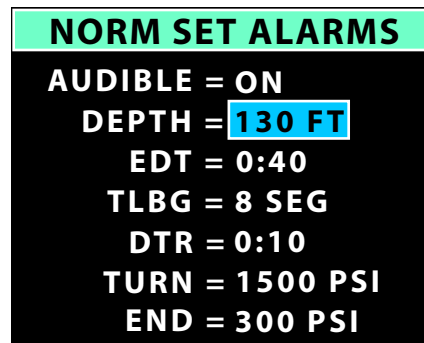

DIVE MAIN

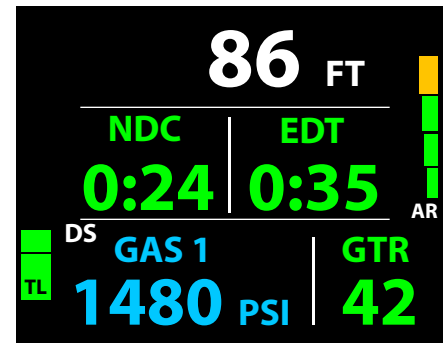

DISPLAY ICONS & GRAPHIC ABBREVIATIONS

(Full character graphics, such as AUDIBLE, are not listed below.)

A, AM	= Am (time)	M	= Meters (depth)
AL	= Alarm	M.D	= Month & Day (date)
AR	= Ascent Rate Indicator	MAX	= Maximum
AV	= Average	MIN	= Minimum, Minutes (time)
AVAIL	= Available	N	= North (compass)
BAR	= Metric unit (pressure)	NDC	= No Deco Time Remaining
BT	= Bluetooth	NDL	= No Deco Limit (time)
C	= Centigrade (temperature)	NI	= Nitrogen
CAL	= Calibration (compass)	No.	= Number
CDT	= Countdown Timer	NORM, NOR	= Normal Scuba Mode
CONSERV	= Conservative Factor	O2	= Oxygen
D.M	= Day & Month (date)	OTR	= O2 Time Remaining
DA	= Depth Alarm	P, PM	= Pm (time)
DC	= Dive Computer	PO2	= Partial Pressure of O2 (ATA)
DECO	= Decompression	PSI	= Pounds per Square Inch (pressure)
DESAT	= Desaturation (nitrogen)	RTI	= Repeating Time Interval
DS	= Deep Stop	S	= South (compass)
DSAT	= Algorithm type	SAT	= Saturation
DTR	= Dive Time Remaining	SEC	= Seconds (time)
E	= East (compass)	SEG	= Segments (bar graph)
EDT	= Elapsed Dive Time	SI	= Surface Interval
EL, ELEV	= Elevation (altitude level)	SPG	= Submersible Pressure Gauge
EMERG.	= Emergency	SURF	= Surface (mode, time)
F	= Fahrenheit (temperature)	TAT	= Total Ascent Time (deco)
FO2	= Fractional % of Oxygen	TEMP	= Temperature
FREE	= Free Dive Mode	TL, TLBG	= Tissue Loading Bar Graph
FT	= Feet (depth)	TMT	= Transmitter (tank pressure)
GAUG, GAU	= Digital Gauge Scuba Mode	W	= West (compass)
GTR	= Gas Time Remaining	Z+	= Algorithm type
INFO	= Information		

POWER SUPPLY

- VTX Battery >> (1) 3 vdc, CR2, Lithium, 800 mAh - Duracell, Energizer, Panasonic, or RayOvac recommended.
- Use life (examples) >> 15 hours at 100% Brightness with Auto Dim set OFF; 34 hours at 60% Brightness with Auto Dim To time set for 10 seconds and Dim level set for 10%. Refer to page 62 for more information relating to power usage.

Once a low battery alarm condition occurs (red icon flashing), sufficient time should be available to ascend to the surface while Brightness is held to 60% maximum.

- Transmitter Battery (each) >> (1) 3 vdc, CR2, 800 mAh, Lithium.
- Use life >> 300 dive hours if (2) 1 hour dives per dive day.
- Replacement >> by user (annual recommended).

POWER SAVER MODE (PSM)

When 2 minutes elapse without any button being pressed while on the surface, the unit will enter a Power Saver Mode (PSM) which turns the display screen off until a button is pressed at which time it will turn back on.

During the time that the screen is off, operations continue as normal in the background with current updated information displayed after the screen comes on again.

An Auto Dim feature can also be used to save power during dives by dimming the display screen to a % level of Brightness that you set prior to the dives. Oceanic recommends that you take advantage of this feature. Refer to pages 13 and 62.

BATTERY STATUS

To access, while viewing the Home Menu when on the surface >>

- S (< 2 sec) to access Home Setup Menu, then -
- A or M (< 2 sec) until BATT, TMT STATUS is highlighted (Fig. 5).
- S (< 2 sec) then activates the unit's receiver displaying a Please Wait message (Fig. 6A) for 3 seconds, then the Status screen appears (Fig. 6B).

A color coded Low Battery icon is displayed at the lower/left of Surface and Dive Main screens when battery power is low.

- No icon = means battery power is good and you have sufficient power to conduct normal diving activities.
- Yellow = caution (warning), meaning you should have sufficient battery power to complete a normal 1 hour dive.
- Red (while on the surface) = alarm, meaning the battery must be changed prior to starting a dive.
- Red (during a dive) = alarm, meaning you should safely ascend to the surface and replace the battery before continuing with diving activities. *Caution - The unit may shut off at any time without further warning.*

LOW BATTERY WARNING

- The Battery icon will be displayed (yellow) when voltage decreases to 2.75 vdc.
- Battery change prior to any diving is recommended. *Less than 1 hour dive time may be expected.*
- The graphics LOW BATTERY will alternate with NORM (or GAUG or FREE) on the Surface Main (Fig. 7).
- If a dive is started, the graphic is not displayed on the dive mode screens.
- Brightness level will be limited to 60% with other functions continuing as usual.

LOW BATTERY ALARM

- The Battery icon will change from yellow to red (flashing) when voltage decreases to 2.50 vdc.
- Entry into dive modes and compass use is blocked. Battery change is required prior to starting any dives.
- The graphics CHANGE BATTERY (red) will flash on the Surface Main (Fig. 8A) until the battery is changed or the unit shuts off due to voltage being too low to sustane operations.
- If a dive is in progress, the red Battery icon will flash and the graphics GO UP LOW BATTERY (red) will be displayed with 2 Red Up Arrows (Fig. 8B) that will alternate with the usual information displayed until on the surface.

Ascent should be made to the surface following proper ascent protocols, respecting ascent speeds allowed, and Deco and Safety Stops if possible.

TRANSMITTER (TMT) BATTERY STATUS

Indication is provided only while on the surface.

Low Battery Warning

- The graphics BATT LOW appear solid (yellow) on the Status screen (see Fig. 6B).
- DC functions continue to be available (surface and dive).

Low Battery Alarm

- The graphics TMTx LOW BATTERY (red) alternate with the graphics NORM (or GAUG) on the SURF Main screen (Fig. 9).
- The graphics BATT LOW (red) also flash on the Status screen.
- TMT operation continues until Tank Pressure decreases to 50 PSI at which time the TMT's link is lost.

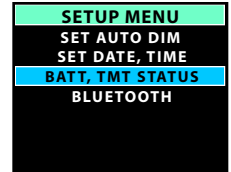

Fig. 5 - HOME SETUP MENU (to access Battery Status)



Fig. 6A - BATTERY STATUS MESSAGE

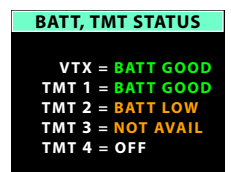

Fig. 6B - BATTERY STATUS

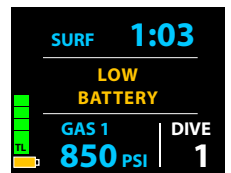

Fig. 7 - VTX LOW BATTERY WARNING

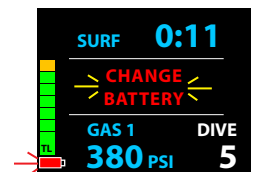

Fig. 8A - LOW BATTERY ALARM (on surface)

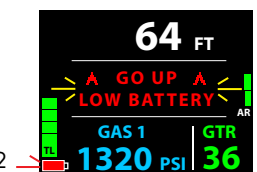

Fig. 8B - LOW BATTERY ALARM (during dive)

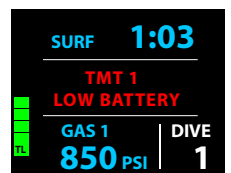

Fig. 9 - TMT LOW BATTERY ALARM

BRIGHTNESS CONTROL

The level (%) of screen Brightness can be adjusted by accessing the Brightness Adjustment screen while viewing the Home Menu screen, or a Surface or Dive Main screen (NORM, GAUG, or FREE), or the Compass OP Main screen.

- A (2 sec), while on the surface or during dives, will access a Brightness adjustment screen with the last % highlighted and flashing. *During a Low Battery Warning or Alarm condition, the level will be limited to 60% maximum.*

ADJUST BRIGHTNESS, information is to include (Fig. 10):

- > xx % (last value saved), flashing.
- S (2 sec) to step back to the screen from which access was gained without changing the % value.
- A (< 2 sec) to step upward through values of 10% to 100% one at a time in increments of 10%.
- M (< 2 sec) to step down through values one at a time.
- S (< 2 sec) to save the % setting and revert to the screen from which access was gained.

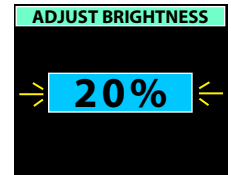

Fig. 10 - BRIGHTNESS ADJUSTMENT

TIP: When an adjustment is made during a dive that is lower than the Auto Dim % set prior to the dive, the screen will remain illuminated at the level you save until you adjust it to a % level above the Auto Dim % set.

AUDIBLE ALARM

While operating in NORM or GAUG Mode, the Audible will emit 1 beep per second for 10 seconds when alarms strike, unless it is set Off. During that time, the Audible can be acknowledged and silenced by pressing S (< 2 sec).

The Audible will not be active when it is set OFF (a Set Alarms Menu selection).

FREE Dive Mode alarms, which emit 3 short beeps either 1 or 3 times, cannot be acknowledged or set OFF.

Alarms that strike during operations in Compass Mode are described on page 45.

Situations that will activate the NORM/GAUG 10 second Alarm include -

- Gas Time Remaining (GTR) at 5 minutes, then again at 0 minutes.
- Turn Pressure at the value set (Transmitter 1 only).
- End Pressure at the value set (active Transmitter).
- Descent deeper than the Depth Alarm value set.
- Dive Time Remaining at the value set**.
- Elapsed Dive Time at the value set.
- PO2 level at .20 < value set for the gas in use and again at the value set**.
- O2 accumulation at 240 OTU (80%), then again at 300 OTU (100%)**.
- TLBG at the value set**.
- Ascent Rate (alarm = all 5 segments) exceeds 60 FPM (18 MPM) when deeper than 60 FT (18 M), or 30 FPM (9 MPM) at 60 FT (18 M) and shallower.
- Loss of the active Transmitter Link signal for more than 15 seconds during a dive.
- Entry into Decompression (Deco)**.
- Conditional Violation (above a required Deco Stop Depth < 5 minutes)**.
- Delayed Violation (above a required Deco Stop Depth => 5 minutes)**.
- Delayed Violation (a Deco Stop Depth > 60 FT/18 M is required)**.
- Delayed Violation (Depth > 330 FT/100 M).
- A Gas Switch would expose the diver to PO2 => 1.60 ATA for that gas**.

** Items apply only in NORM mode.

A single short beep (which cannot be disabled) sounds when -

- 5 minutes elapse on the surface after the Violation dive.

3 short beeps (which cannot be disabled) sound when -

- Ascent Rate (warning = 4 segments) is 51 to 60 FPM (15.1 to 18 MPM) when deeper than 60 FT (18 M), or 26 to 30 FPM (7.5 to 9 MPM) at 60 FT (18 M) and shallower.
- FREE Dive Repeating Time Interval Alarm - 3 beeps once every 30 seconds, if set On.
- FREE Dive Depth Alarms 1, 2, 3 - 3 beeps 3 times at each value set.
- FREE Dive TLBG Alarm (Caution zone, 7 segments) - 3 beeps 3 times.
- FREE Dive Violation - 3 beeps 3 times upon entry into Decompression.
- FREE Countdown Timer - 3 beeps 3 times when time counts down to 0:00.

During the following situations, the audible will not turn off when acknowledged -

- Delayed Violations 1, 2, 3.
- Deco Stop Depth Violation => 70 FT/21 M stop required.
- FREE mode alarms.

OPERATING MODES

HOME >> This is a base mode that provides access to general items common to the operating dive modes.

NORM >> This is an operating dive mode used for Air and Nitrox scuba activity with up to 4 gases and transmitters.

If no previous dive has been taken within the past 24 hours, NORM is the default mode upon activation with others accessed as described later.

GAUG >> This is an operating dive mode used for scuba activity with up to 4 transmitters but without Ni-O2 calculations.

Once a GAUG dive has been conducted, operation locks into this mode for 24 hours.

FREE >> This is an operating dive mode used for breath hold diving activity with depth/time indication.

Ni-O2 calculations are performed while in FREE mode and are carried over between NORM and FREE.

COMPASS >> This is the navigation mode that can be used at any time while on the surface and during dives.

At any time while operating in Surface Modes*, operation will enter the Dive Mode selected upon descent to 5 FT (1.5 M) for 5 seconds.

**When a Low Battery Alarm condition is present, BATT icon is red, entry into Dive Modes is blocked.*

Operation shifts from Dive Mode to Surface Mode upon ascent to 2 FT (0.6 M) for 1 second; however, most surface mode screens will not be available until a transition time elapses.

The reason for this is that making a descent during the first 10 minutes after surfacing from a NORM or GAUG dive, or during the first 1 minute after surfacing from a FREE dive, is a continuation of that same dive.

A descent made after the 10 minute (or 1 minute) interval has elapsed is then considered a new dive.

During the first 10 minutes after surfacing from a NORM or GAUG dive, or the first 1 minute after surfacing from a FREE dive, the Dive Main screen will be displayed with Surface Interval time replacing Current Depth. Dive ALTs can be accessed to view other information pertaining to that dive.

MODE STRUCTURE

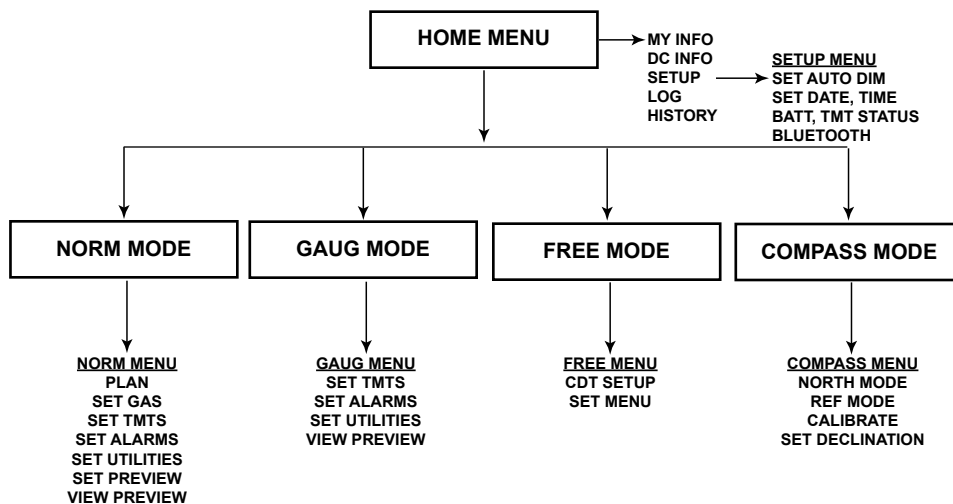

HOME MODE

HOME MENU

The Home Menu is displayed after activation and diagnostics. When the NORM, GAUG, FREE, or Compass Surface Main screen is displayed, the Home Menu can be accessed by pressing M for 2 seconds.

- At any time while operating in the Home Menu system, pressing M (2 sec) will revert to the Home Menu screen.
- Operation will also revert to the Home Menu screen if no button is pressed within a 2 minute period.

Selections include (Fig. 11) -

- > MY INFO - select to view personal information entered using the PC or Mac interface program.
- > DC INFO - select to view information describing the dive computer, or to clear residual Ni-O2 used for calculations.
- > SETUP - select to access the Setup Menu.
- > LOG - select to access the NORM/GAUG Log data recorded for viewing.
- > HISTORY - select to access the NORM/GAUG History data recorded for viewing.
- > NORM - select to access the NORM operating mode for scuba activities.
- > GAUG - select to access the GAUG operating mode for scuba activities.
- > FREE - select to access the FREE operating mode for breath hold diving activities.
- > COMPASS - select to access the Compass operating mode for navigation.

- A (2 sec) - to access Adjust Brightness (refer to page 8).
- A (< 2 sec) - to step forward (down) through the Menu selections. *Down the left column, then down the right column.*
- M (< 2 sec) - to step back (up) through the selections.
- S (< 2 sec) - to access the highlighted selection.

MY INFO (view only)

Up to 7 lines of information containing up to 16 characters each can be entered using the PC or Mac interface system.

Prior to personal information being entered, a graphic message is displayed as a reminder to enter your data (Fig. 12A).

Examples of information that can be entered include (Fig. 12B):

- > Name.
 - > Phone number.
 - > Address.
 - > Medical.
 - > Emergency contact.
- S (2 sec) - to step back to the Home Menu.

DC INFO (view only)

This information should be recorded and kept, it will be required in the event that your unit requires factory service.

Information displayed with the screen title includes (Fig. 13):

- > Model - assigned by the factory.
- > Serial number - assigned by the factory.
- > Firmware revision* - level currently installed in the unit.
- > Date of last calibration - assigned by the factory.

**This number will change if Firmware is updated by factory service or by future download of revised firmware from the Oceanic web site.*

- S (2 sec) - to step back to the Home Menu.
- S (< 2 sec) - to access the Clear Ni-O2 Calculations screen.

CLEAR NI-O2 CALCULATIONS

This feature gives you the ability to reset the unit, clearing all nitrogen and oxygen calculations.

Information displayed with the screen title includes (Fig. 14):

- > Graphics ENTER CODE TO CLEAR NI - O2 CALCULATIONS.
 - > 4 digit number (xx - yy, some random assignment by the factory, *not 20 - 02 which is the correct reset code*).
- S (2 sec) - to revert to the DC INFO screen, if you want to exit the routine without resetting the unit.

Reset procedure:

- S (< 2 sec) - to start the first 2 digits (xx on the left) flashing.
- A (hold) - to scroll upward through the first digits (xx) 4 per sec.
- A (< 2 sec) - to step upward through the digits (xx) one at a time.
- M (< 2 sec) - to step back through the digits (xx) one at a time.
- S (< 2 sec) - to save the first 2 digits (xx) and flash the second 2 digits (yy on the right).
- A (hold) - to scroll upward through the second digits (yy) 4 per sec.
- A (< 2 sec) - to step upward through the digits (yy) one at a time.
- M (< 2 sec) - to step back through the digits (yy) one at a time.
- S (< 2 sec) - to save the Reset Code, clear the unit (if [20 - 02]), and turn the unit off with all nitrogen/oxygen calculations and data being erased..
- S (2 sec) - to revert to the DC INFO screen, if you want to exit the routine without resetting the unit.

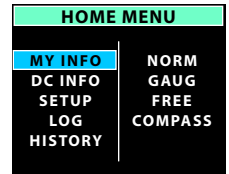

Fig. 11 - HOME MENU

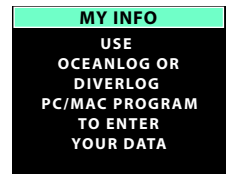

Fig. 12A - MY INFO (prior to any entries)

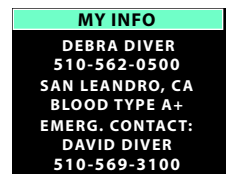

Fig. 12B - MY INFO (sample of entries made)

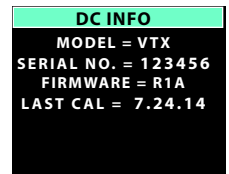

Fig. 13 - DC INFO (sample of entries made)

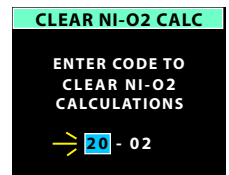

Fig. 14 - CLEAR (sample of entries made)

HOME SETUP MENU, selections include (Fig. 15):

- > SET AUTO DIM - select to access the Set Auto Dim feature.
- > SET DATE, TIME - select to access the Set Date, Time Menu.
- > BATT, TMT STATUS - select to activate the VTX' receiver then view status information for the VTX and Transmitters.
- > BLUETOOTH - select to initialize the Bluetooth function.

- A (< 2 sec) - to step forward (down) through the Menu selections.
- M (< 2 sec) - to step back (up) through the selections.
- S (< 2 sec) - to access the highlighted selection.
- S (2 sec) - to revert to the Home Menu.

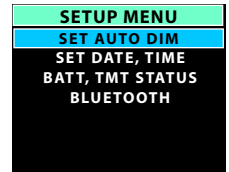

Fig. 15 - HOME SETUP MENU

SET AUTO DIM, selections with the last settings saved include (Fig. 16A/B):

This feature will allow you to set a time that Dive Main screens will remain illuminated (after the last button press) at the Brightness % level you adjusted it to before it is reduced to the Dim level that you set it to here.

- > TIME UNTIL DIM with the graphic OFF, or 0:30 MIN:SEC, flashing.
- > DIM TO BRIGHTNESS with 30 %.
- A (hold) - to scroll upward through Time set points 8/sec from OFF to 0:20 through 2:00 MIN:SEC in increments of 10 seconds (0:10).
- A (< 2 sec) - to step upward through the Time set points one at a time.
- M (< 2 sec) - to step back through the Time set points one at a time.
- S (< 2 sec) - to save the Time setting.

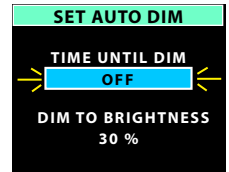

Fig. 16A - SET AUTO DIM

If OFF is selected, the Dim To Brightness setting is to be bypassed with operation reverting to the Home Setup Menu. The Auto Dim feature is to be disabled and have no affect during dives.

If a min:sec Time value is saved, it is to become solid and Dim To Brightness % is to be highlighted and flash.

- S (2 sec) - to step back to the Setup Menu without saving the setting.
- A (< 2 sec) - to step upward through the % Dim set points from 10 through 60% in increments of 10% one at a time.
- M (< 2 sec) - to step back through the % set points one at a time.
- S (< 2 sec) - to save the setting, which is to become solid with the highlight removed, and revert to the Home Setup Menu with the Set Auto Dim selection highlighted allowing other operations.
- S (2 sec) - to step back to Set Time without saving the setting.

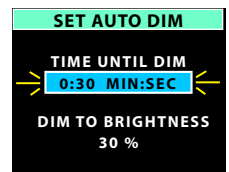

Fig. 16B - SET AUTO DIM

SET DATE, TIME MENU, selections with the last settings saved include Fig. 17):

- > DATE FORMAT = with M.D (for Month.Day) or D.M (for Day.Month).
- > DATE = with Month.Day.Year or Day.Month.Year, based on the Date Format. *Set Year, then Month, then Day..*
- > HOUR FORMAT = with 12 (12: Am to 11: Pm) or 24 (0: to 23:).
- > TIME = with hr:min (12:01 A to 11:59 P, if 12 Hour Format; or 0:01 to 23:59, if 24 Hour Format). *Set Year, then Minute.*

- A (< 2 sec) - to step forward (down) through selections.
- M (< 2 sec) - to step back (up) through selections.
- S (< 2 sec), when a selection is highlighted - to highlight and flash that item's set point (see below).
- A (< 2 sec) - to toggle or increase set points one at a time.
- A (hold) - to increase set points at a rate of 8 per second.
- M (< 2 sec) - to toggle or decrease set points one at a time.
- S (< 2 sec) - to save the setting which becomes solid, with the selection flashing.
- S (2 sec) - to revert to the Setup Menu.

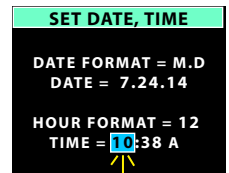

Fig. 17 - SET DATE, TIME MENU

BATTERY/TMT (TRANSMITTER) STATUS, information includes (Fig. 18):

Also refer to page 8.

- > VTX = BATT GOOD (or LOW)
- > TMT 1 = BATT GOOD (or LOW), or NOT AVAIL, or OFF
- > TMT 2 = BATT GOOD (or LOW), or NOT AVAIL, or OFF
- > TMT 3 = BATT GOOD (or LOW), or NOT AVAIL, or OFF
- > TMT 4 = BATT GOOD (or LOW), or NOT AVAIL, or OFF

*GOOD (green) means that battery power is acceptable (=> 2.75 volts).
 LOW (yellow) means that the battery should be changed (< 2.75 volts, warning level).
 LOW (red, flashing) means that the battery must be charged prior to further operations (< 2.50 volts, alarm level).
 NOT AVAIL means that the VTX's receiver is not receiving that Transmitter's signal.
 OFF means that the Transmitter has not been selected for use.*

- S (2 sec) - to revert to the Setup Menu.
- 10 sec - revert to the Setup Menu if S is not pressed.

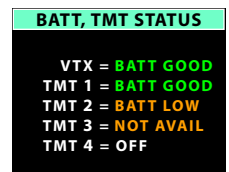

Fig. 18 - BATTERY/TMT STATUS

BLUETOOTH

The VTX contains a Bluetooth module that can be paired with a PC, Mac, or mobile device.

Bluetooth is initialized while the selection is highlighted on the Home Setup Menu (by S < 2 sec).

A Please Wait screen (Fig. 19A) will be displayed for 5 seconds followed by a screen displaying a countdown from 120 to 0 seconds (Fig. 19B).

If Bluetooth fails to initialize, a message will be displayed for 3 seconds instead of the countdown (Fig. 19C), then operation will revert to the Home Setup Menu.

During the countdown, the unit is on allowing it to be paired with other Bluetooth devices.

- > Mobile devices require Diverlog for Mac software that contains files required to discover and communicate with the Bluetooth chip in the VTX. Likewise, laptops and desktops are only able to discover the VTX through Diverlog for Mac or the OceanLog PC Interface program with the use of an optional dongle that can be obtained from an Oceanic Dealer.
- > Once paired, a connected message is displayed (Fig. 19D) with the signal icons <<<< changing from white to green while the Download, Upload, or Firmware Update operation is started.
- > Once the VTX is unpaired from the PC, Mac, or mobile device, it will be necessary to pair/connect it through the software before every download/upload.
- > Pairing/connecting is not permanent and needs to be reestablished every time.
- > This connection functions the same way the USB does in the Diverlog and OceanLog programs.
- > If the 2 minute countdown elapses without action, operation will revert to the Home Setup Menu and the connection request of the OceanLog, Diverlog, or iPhone/iPad version software will be cancelled.
- > If the connection is cut using the software, operation will revert to the Home Setup Menu.

While downloading data, uploading settings, and updating firmware, corresponding screens are displayed indicating action in progress (Fig. 19E, 19F, 19G).

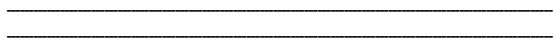

Fig. 19A - BLUETOOTH (initializing)



Fig. 19B - BLUETOOTH (countdown for pairing)



Fig. 19C - BLUETOOTH (failed to initialize)

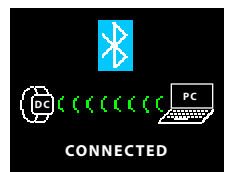

Fig. 19D - BLUETOOTH (ready to start operation)

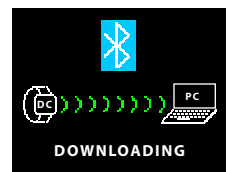

Fig. 19E - BLUETOOTH (in progress)



Fig. 19F - BLUETOOTH (in progress)



Fig. 19G - BLUETOOTH (failed to initialize)

LOG MODE (NORM/GAUG)

Information from the latest 24 NORM and/or GAUG dives is stored for viewing. After exceeding 24 dives, the most recent dive is stored while the oldest is deleted.

- > Dives are numbered from 1 to 24 starting each time NORM (or GAUG) mode is activated. After 24 hours elapse with no dive, the first dive of the next period of operation is #1.
- > 10 minutes after a dive, the Log screens for all dives stored can be viewed.

If a dive's elapsed time (EDT) exceeds 9:59 (hr:min), data at the 9:59 interval is recorded in the Log upon surfacing of the unit.

Screen sequence = Log Entry Finder (index) >> Data 1 >> Data 2 >> Data 3.

Prior to any dives being recorded (new unit out of the box), the graphics NONE YET are displayed (Fig. 20A) on the Log Entry Finder screen when the Log Mode is accessed from the Home Menu by S (< 2 sec).

- S (2 sec) - to revert to the Home Menu.

Log Entry Finder, information includes 3 columns (Fig. 20B):

- > Entry number - 1 to 99, most recent first (at top).
- > Date of the dive.
- > Dive # for that day, or that series of repetitive dives.

The down arrow on the scroll bar at the right will be green if additional entries are listed going down and grey if there are no more entries. The up arrow will be green if additional entries are listed going up and grey if there are no more entries.

- A (hold) - to scroll forward (down) through the listing at a rate of 8 entries per second.
- A (< 2 sec) - to step forward (down) through the listing.
- M (< 2 sec) - to step back (up) through the listing.
- S (< 2 sec) - to access that dive's Log Data 1 screen (for the dive highlighted).
- S (2 sec) - to revert to Home Menu.

Log Data 1, information includes (Fig. 20C, 20D):

- > Log Entry # (the # shown in the screen title matches the dive selected from the Finder listing).
- > TYPE = NO DECO (or DECO, or VIOLA, or GAUG).
- > ELEV = SEA (or EL 2 to EL 7). *Altitude level of the dive.*
- > PRE DIVE SI = hr:min. *Surface Interval time before the dive.*
- > START TIME = hr:min.
- > DIVE TIME = hr:min. *Elapsed time of the dive.*
- > MAX DEPTH = xxx FT (or xx.x M). *Maximum recorded during that dive.*
- > MIN TEMP = xx F (or C). *Minimum recorded during that dive.*

- S (< 2 sec) - to access that dive's Log Data 2 screen.
- S (2 sec) - to step back to the Finder screen with that dive highlighted.

Log Data 2, information includes (Fig. 20E, 20F):

- > Log Entry # (the # shown in the screen title matches the dive selected from the Finder listing).
- > LAST GAS = AIR; or FO2, PO2 Alarm settings. *For the last gas used during that dive. Blank if a GAUG dive.*
- > AV DEPTH = xxx FT (or xx.x M). *Average for that dive.*
- > AV TEMP = xx F (or C). *Average for that dive.*
- > START = xxxx PSI (or xxx BAR). *Tank 1 pressure when the dive started.*
- > END = xxxx PSI (or xxx BAR). *Pressure of the tank in use when the dive ended.*
- > MAX PO2 = x.xx. *Highest level reached during that dive. Blank if an Air or GAUG dive.*
- > O2SAT = xx%. *Level of O2 saturation when the dive ended. Blank if an Air or GAUG dive.*

- S (< 2 sec) - to revert to the Finder screen with that dive highlighted.
- S (2 sec) - to step back to that dive's Log Data 1 screen.

HISTORY MODE (NORM/GAUG), information includes (Fig. 21):

History is a summary of data recorded during all NORM and GAUG dives conducted.

- > TOTAL DIVES = xxxx (up to 9999).
- > TOTAL HOURS = xxxx (up to 9999).
- > MAX DEPTH = xxx FT (or xx.x M). *Deepest depth of any dive, down to 330 FT (100 M).*
- > MAX EDT = x:xx (hr:min). *Longest time of any dive, up to 9:59 (hr:min).*
- > MAX ELEV = SEA (or EL 2 to EL 7). *Highest altitude level of any dive.*
- > LOW TEMP = xx F (or C). *Lowest recorded during any dive.*

- S (2 sec) - to step back to the Home Menu.



Fig. 20A - LOG MODE (no dives recorded yet)

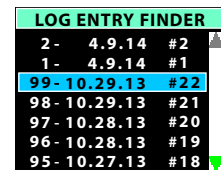

Fig. 20B - LOG FINDER (locate dives by entry & date)



Fig. 20C - LOG DATA 1 (NORM Dive)

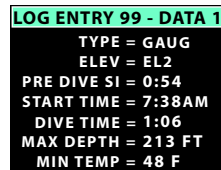

Fig. 20D - LOG DATA 1 (GAUG Dived)

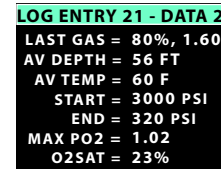

Fig. 20E - LOG DATA 2 (NORM Dive)

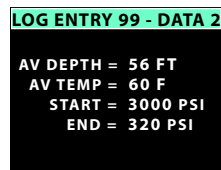

Fig. 20F - LOG DATA 2 (Air or GAUG Dive)

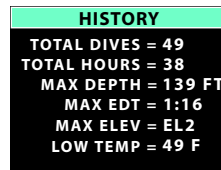

Fig. 21 - HISTORY MODE (cumulative summary)

NORM

SURFACE MODE

NORM SURFACE MODE

Upon access to NORM mode, the Surface Main screen will be displayed during which time the unit will enter Dive Mode upon descent to 5 FT (1.5 M) for 5 seconds.

If 2 minutes elapse with no button action, operation will enter Power Saver Mode turning the screen off until a button is pressed.

The unit will enter Post Dive Surface Mode upon ascent to 2 FT (0.6 M) for 1 second and display the Surface Main with the SURF icon flashing.

Access to Alternate screens is allowed during the first 10 minutes with access to other surface modes/screens blocked until 10 minutes elapse. *Exception is for Violations.*

When the 10 minute post dive surface Interval time has elapsed, access to other Surface modes/screens is allowed.

NORM SURF MAIN, information includes (Fig. 22A/B):

- > Surface Interval Time (hr:min, colon flashing), with SURF icon (flashing during the first 10 minutes after surfacing).
- > Graphic NORM; or NDC as 3 dashes (- : - -) & EDT (hr:min) with icons during the first 10 minutes after surfacing.
- > Graphic GAS 1 (start Gas & default 10 minutes after a dive), Gas in use during the first 10 minutes after surfacing.
- > Tank 1 Pressure with PSI (or BAR) icon (start TMT & default TMT 10 minutes after a dive), graphic SPG (meaning Submersible Pressure Gauge) if no TMT is in use; TMT in use during first 10 min after surfacing.
- > Graphic DIVE with number of that dive (up to 24), 0 if no dive yet (or 2 dashes - - with GTR icon during the first 10 minutes after surfacing).
- > TLBG, if any after a NORM or FREE dive.
- > Low Battery icon - yellow (if voltage is at the warning level), or red flashing (if voltage is at the alarm level).

- A (2 sec) - to access the Adjust Brightness screen.
- A (< 2 sec) - to access NORM SURF ALT 1.
- M (2 sec) - to revert to the Home Menu.
- M (< 2 sec) - to access the NORM Menu.
- S (2 sec) - to access the Compass OP Main.

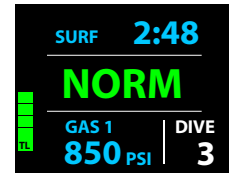

Fig. 22A - NORM SURF MAIN (2 hours after dive 3)

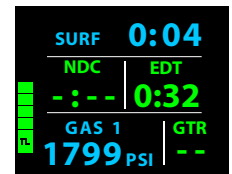

Fig. 22B - NORM SURF MAIN (< 10 min after surfacing)

ADJUST BRIGHTNESS, information includes (Fig. 23):

- > xx % (last value saved). *Up to 60% max when Low Battery Warning or Alarm.*
- S (2 sec) - to step back to the SURF MAIN without changing the value.
- A (< 2 sec) - to step upward through values of 10% to 100% one at a time in increments of 10%.
- M (< 2 sec) - to step down through values one at a time.
- S (< 2 sec) - to save the % setting and revert to the SURF MAIN.

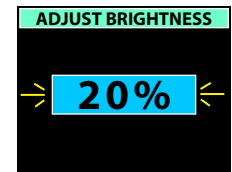

Fig. 23 - BRIGHTNESS CONTROL

NORM SURF ALT 1, information includes (Fig. 24):

- > LAST DIVE (screen title).
- > xxx FT (or xx.x M) with graphic MAX DEPTH.
- > Elapsed Dive Time (hr:min, up to 9:59) with graphic DIVE TIME.

- A (< 2 sec) - to access SURF ALT 2.
- M (< 2 sec) - to step back to the SURF MAIN.
- 10 sec with no button action, revert to the SURF MAIN.

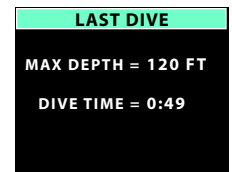

Fig. 24 - NORM SURF ALT 1

NORM SURF ALT 2, information includes (Fig. 25):

- > DATE = m.d.y (or d.m.y).
- > TIME = hr:min with AM (or PM) if 12 Hour Format.
- > TEMP = xx F (or C).
- > ELEV = SEA (or EL2 to EL7).
- > FLY = hr:min*
- > DESAT = hr:min**
- > O2 SAT = xx%.
- > GAS 1 = AIR; or xx%, x.xx (FO2, PO2 set).

- A (< 2 sec) - to revert to SURF MAIN.
- M (< 2 sec) - to step back to SURF ALT 1.
- 10 sec with no button action, revert to SURF MAIN.

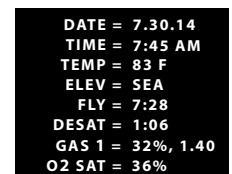

Fig. 25 - NORM SURF ALT 2

*The Time to Fly counter will begin counting down from 23:50 to 0:00 (hr:min) 10 minutes after surfacing from any dive.

**The Time to Desaturate counter provides calculated time for Tissue Desaturation at sea level taking into consideration the Conservation Factor setting. It will begin counting down 10 minutes after surfacing from a NORM or FREE dive, counting down from a maximum of 23:50 to 0:00 (hr:min).

Desaturation requiring times greater than 24 hours will display the graphic > 24:00. In the event that Time to Desaturate still remains at the end of 24 hours, the unit will turn Off and any Ni-O2 calculations will clear.

NORM MENU, information includes (Fig. 26):

- > PLAN - to view a sequence of allowed depths with no deco times.
- > SET GAS - to access a menu for setting FO2 and PO2 alarms for each gas.
- > SET TMTS - to access a menu for setting transmitters.
- > SET ALARMS - to access a menu for setting dive alarms.
- > SET UTILITIES - to access a menu for setting dive related functions such as algorithm, stops, etc.
- > SET PREVIEW - to access a menu for selecting dive related settings to be viewed together.
- > VIEW PREVIEW - to view items selected.

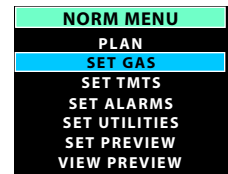

Fig. 26 - NORM MENU

- A (< 2 sec) - to step forward (down screen) through Menu selections (the active item highlighted).
- M (< 2 sec) - to step back (up screen) through Menu selections.
- S (< 2 sec) - to access the selection that is highlighted.
- M or S (2 sec) - to step back from the Menu to the NORM SURF MAIN.
- M (2 sec) - to exit the Menu system and revert to the NORM SURF MAIN.
- No button action (for 2 min) - will exit the Menu system and revert to the NORM SURF MAIN.

NORM PLAN MODE

No Deco time Limits (NDLs) and O2 time Limits (OTLs) in Plan Mode are based on the Algorithm selected (DSAT or Z+), the FO2 set for Gas 1, and residual nitrogen (or O2) remaining from previous NORM (or FREE) dives. FO2 set for other Gases are not used for Plan calculations.

PDPS (Pre Dive Planning Sequence)

Plan screens will sequence through Depths from 30 to 190 FT (9 to 57 M), or the Max Depth that will allow theoretical No Deco Dive Time of at least 1 minute based upon the previous dive profiles in a series of repetitive dives and taking into account descent and ascent rates of 60 FPM (18 MPM).

When the Conservative Factor is set On, NDLs are reduced to the values of the next 3,000 foot (915 meter) higher Altitude. Refer to tables in back.

PLAN GAS 1, information includes (Fig. 27A/B):

- > Graphic AIR; or xx%, x.xx - xxx FT (or M) [FO2, PO2 set with the Max Depth allowed for the PO2 alarm value set].
- > Plan Depth value with FT (or M) icon.
- > Dive Time allowed (hr:min) with graphic NDL (or OTL if O2 control).

- A (hold) - to scroll 8/sec (down screen) through the available Plan Depths from 30 to 190 FT (9 to 57 M) in increments of 10 FT (3 M) highlighting the information one line at a time.

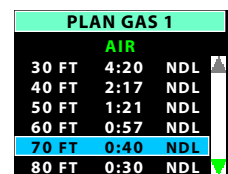

Fig. 27A - PDPS (Gas 1 set for Air)

The down arrow on the scroll bar at the right will be green if other deeper depths will be listed when going down and grey if there is no other depth listed below. The up arrow on the scroll bar will be green if other shallower depths will be listed when going up and grey if there is no other depth listed above.

- A (< 2 sec) - to step forward (down) through the Plan Depths one at a time.
- M (< 2 sec) - to step back (up) through the Plan Depths one at a time.
- S (< 2 sec) - to exit the PDPS and revert to the Main Menu.

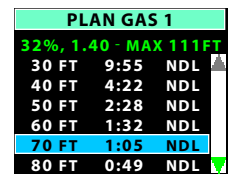

Fig. 27B - PDPS (Gas 1 set for Nitrox)

The PDPS will step/scroll to the Max Depth that will allow a theoretical No Deco time of at least 1 minute based upon previous dive profiles in a series of repetitive dives.

Once a dive is conducted, the algorithm selected will lock into that selection until 24 hours elapse on the surface after the dive, or all residual nitrogen has been offgassed (DSAT time = 0:00).

SET GAS MENU (NORM), information includes (Fig. 28A):

Selections with their last set points saved include:

- > GAS 1 = with AIR; or 21 to 100% and 1.xx (PO2 alarm setting).
- > GAS 2 = with OFF; or AIR; or 21 to 100% and 1.xx (PO2 alarm setting).
- > GAS 3 = with OFF; or AIR; or 21 to 100% and 1.xx (PO2 alarm setting).
- > GAS 4 = with OFF; or AIR; or 21 to 100% and 1.xx (PO2 alarm setting).

- A (< 2 sec) - to step forward (down screen) through and highlight Menu selections.
- M (< 2 sec) - to step back (up screen) through Menu selections.
- S (< 2 sec), when a selection is highlighted - to highlight & flash* that item's set point.

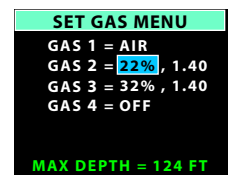

Fig. 28A - SET GAS MENU (Gas 2 selected)

**During the time that a numeric FO2 value is flashing, the Max Depth allowed for the PO2 alarm value shown is displayed at the bottom.*

FO2 set for AIR:

- > The default FO2 for Gas 1 each new activation period is AIR.
- > When FO2 for Gas 1 is set for AIR -
 - > calculations are the same as when it is set for 21% O2.
 - > it remains set for AIR until it is set for a Nitrox (21 to 100% O2).
 - > O2SAT and PO2 values and/or warnings will not be displayed at any time, on the surface or during dives.
 - > Max Depths allowed by the PO2 alarm set will not be displayed.

- > Internally, the unit will keep track of the oxygen accumulation so that if FO2 for Gas 1 is subsequently set for Nitrox, the oxygen accumulated during previous AIR dives will be accounted for in the next Nitrox dive (during that dive period and series of repetitive dives).

FO2 set for Nitrox:

- > When FO2 for any Gas is set for Nitrox (21 to 100%), the dive is calculated to be for Nitrox.
- > Once FO2 for Gas 1 is set for Nitrox (21 to 100%), the AIR option for all gases is disabled until 24 hours elapse after the last dive.
- > The AIR option will not be displayed in Set Gas until a full 24 hour Surface Interval has elapsed.

When the FO2 digits are highlighted & flashing (Fig. 28B):

- A (< 2 sec) - to step up through FO2 set points one at a time from AIR to 21 to 100% in increments of 1%.
- A (hold) - to scroll upward through the FO2 set points at a rate of 8 per second stopping momentarily at 32%, 50%, 80%, and 100%, then at AIR or 21%.
- M (< 2 sec) - to step down through FO2 set points one at a time.
- S (< 2 sec) - to save the FO2 setting and highlight & flash the PO2 digits if Nitrox, or move to GAS 2 if AIR.
- S (2 sec) - to step back to & highlight the GAS # selected without changing the FO2 setting.

When the PO2 alarm digits are highlighted & flashing (Fig. 28C):

- A (< 2 sec) - to step up through the set points one at a time from 1.00 to 1.60 in increments of 0.05.
- M (< 2 sec) - to step down through the set points one at a time.
- S (< 2 sec) - to save the PO2 Alarm setting and step back to & highlight the GAS # selected.
- S (2 sec) - to step back to & highlight the FO2 value without changing the PO2 setting.

FO2 & PO2 Alarms for all gases will remain at their respective set points until changed.

SET TMT MENU (NORM, GAUG), information includes (Fig. 29A):

Selections with their last set points saved include (SET will not be displayed upon access):

- > TMT 1 = with OFF or ON.
- > TMT 2 = with OFF or ON.
- > TMT 3 = with OFF or ON.
- > TMT 4 = with OFF or ON.
- A (< 2 sec) - to step forward (down screen) through and highlight Menu selections.
- M (< 2 sec) - to step back (up screen) through Menu selections.
- S (< 2 sec), when a selection is highlighted - to highlight & flash that item's set point.
- A (< 2 sec) - to step forward through that TMT's set points (OFF, ON, & SET).
- M (< 2 sec) to step back through that TMT's set points.
- S (< 2 sec) - to save the setting.
- > If OFF is selected (saved), the VTX's receiver will be disabled, all other TMT set selections will display the graphic OFF, and operation will revert to the Set Utilities Menu.
- > If ON is selected, ON becomes solid and the next TMT ON/OFF set point will flash, allowing it to be set.
- > If SET is selected, the Set TMT Link Code screen will be displayed.

Set TMT Link Code (Serial Number), information includes (Fig. 29B):

- > Graphics TMT 1 (2, 3, 4) SERIAL NUMBER.
- > 6 digit serial number, the 1st (left) digit flashing.
- A (< 2 sec) - to step upward through the 1st digit's values.
- M (< 2 sec) - to step back through the 1st digit's values.
- S (< 2 sec) - to save the 1st digit's value and flash the 2nd digit.
- Repeat A, M, S button action until all digits are set with operation then reverting to the Set TMT Menu with SET highlighted allowing OFF or ON to be selected.

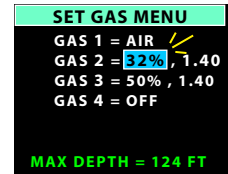

Fig. 28B - SET GAS MENU (setting Gas 2 FO2)

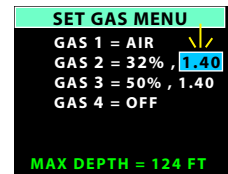

Fig. 28C - SET GAS MENU (setting Gas 2 PO2 Alarm)

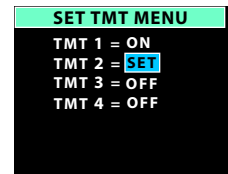

Fig. 29A - TMT SET MENU

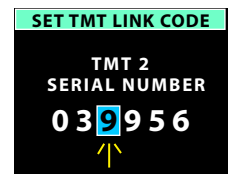

Fig. 29B - SET LINK CODE

SET ALARMS MENU (NORM), information includes (Fig. 30):

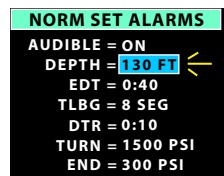

Fig. 30 - SET ALARMS

Selections with their last Set points saved include:

- > AUDIBLE = with ON or OFF.
- > DEPTH = with OFF, or 30 to 330 FT (or 10 to 100 M), increments of 10 FT (3 M).
- > EDT = with OFF, or 0:10 to 3:00 (hr:min), increments of :05. *EDT is Elapsed Dive Time.*
- > TLBG = with 1 to 8 SEG, increments of 1 SEG. *SEG means Segments of the bar graph*
- > DTR = with OFF, or 1 to 0:20 (:min), increments of :01. *DTR is Dive Time Remaining.*
- > TURN = with OFF, or 1000 to 3000 PSI (or 70 to 205 BAR), increments of 250 PSI (5 BAR). *TURN is pressure of TMT 1.*
- > END = with 300 to 1500 PSI (or 20 to 105 BAR), increments of 100 PSI (5 BAR). *END is pressure of the TMT in use.*

- A (< 2 sec) - to step forward (down screen) through and highlight Menu selections.
- M (< 2 sec) - to step back (up screen) through Menu selections.
- S (< 2 sec), when a selection is highlighted - to highlight & flash that item's set point.

- A (< 2 sec) - to toggle or increase the set point.
- A (hold) - to increase the set point at a rate of 8 per second.
- M (< 2 sec) - to toggle or decrease the set point.
- S (< 2 sec) - to save the setting and revert to the Set Alarms Menu.

SET UTILITIES MENU (NORM), information includes (Fig. 31A):

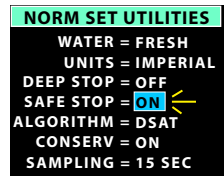

Fig. 31A - SET UTILITIES

Selections with their last Set points saved include:

- > WATER = with FRESH or SEA. *This adjusts depth values based on the type of water.*
- > UNITS = with IMPERIAL or METRIC.
- > DEEP STOP = with OFF or ON. *This only applies to No Deco dives.*
- > SAFE STOP = with OFF or ON. *This only applies to No Deco dives.*
- > ALGORITHM = with DSAT or Z+. *This determines the basis for Ni-O2 calculations.*
- > CONSERV = with OFF or ON. *This, Conservative Factor, reduces NDLs based on altitude level.*
- > SAMPLING = with 2, 15, 30, or 60 SEC (second). *This is the rate that data is sampoled and recorded for PC download.*

Additional information relating to the effects of the items included are described in associated sections throughout this manual.

- A (< 2 sec) - to step forward (down screen) through and highlight Menu selections.
- M (< 2 sec) - to step back (up screen) through Menu selections.
- S (< 2 sec), when a selection is highlighted - to highlight & flash that item's set point.

- A (< 2 sec) - to toggle or increase the set point.
- A (hold) - to increase the set point at a rate of 8 per second.
- M (< 2 sec) - to toggle or decrease the set point.
- S (< 2 sec) - to save the setting and revert to the Set Utilities Menu.

Set Safety Stop

In addition to OFF and ON, Safety Stop has a SET selection.

- S (< 2 sec), while SET is flashing - will display the Set Safe Stop Time/Depth screen with the Time setting flashing (Fig. 31B).
- A or M (< 2 sec) - to toggle TIME between 3 MIN and 5 MIN.
- S (< 2 sec) - to save the Time setting and flash the Depth digits.
- A (< 2 sec) - to step upward through Depth set points of 10, 15, 20 FT (or 3, 4, 5, 6 M).
- M (< 2 sec) - to step back through Depth set points.
- S (< 2 sec) - to save the setting and revert to the Set Utilities Menu with SET highlighted & flashing allowing OFF or ON to be selected/saved (as described above).



Fig. 31B - SET NO DECO SAFETY STOP

SET PREVIEW (NORM), information includes (Fig. 32):

Using this listing, you can chose up to 7 items (set points that have been entered) for display on a Preview screen that can be accessed from the NORM Menu (see page 16).

- > FO2, PO2 alarms set for - Gas 1, 2, 3, 4.
- > Alarm values set for - Depth, EDT, DTR, TLBG, Turn Pressure, End Pressure.
- > Water Type selected.
- > Deep Stop setting.
- > Safety Stop setting.

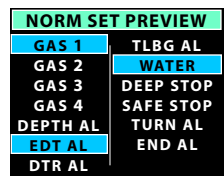

Fig. 32 - SET PREVIEW

- A (< 2 sec) - to step forward (down 1st column then 2nd) through & highlight selections.
- M (< 2 sec) - to step back (up) through selections.
- S (< 2 sec) - when an item is highlighted will toggle* it between solid and flashing.

**Once 7 items are highlighted/flashing, another item cannot be toggled to be highlighted/flashing until one of the highlighted/flashing items is toggled to solid, not highlighted first.*

When satisfied that those items flashing (up to 4) are what you want for the Preview screen, press S (2 sec) to display all items flashing, then press S (< 2 sec) to revert to the Menu with SET PREVIEW highlighted.

NORM DIVE PREVIEW, information includes (Fig. 33):

Upon accessing this screen from the NORM MENU, the items selected using the NORM Set Preview function previously described will be displayed with the settings last saved. The illustration shown is a sampling of various items selected with their settings.

- S or M (2 sec) to step back to the NORM MENU with VIEW PREVIEW highlighted.

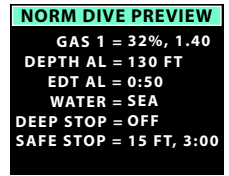
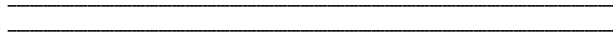
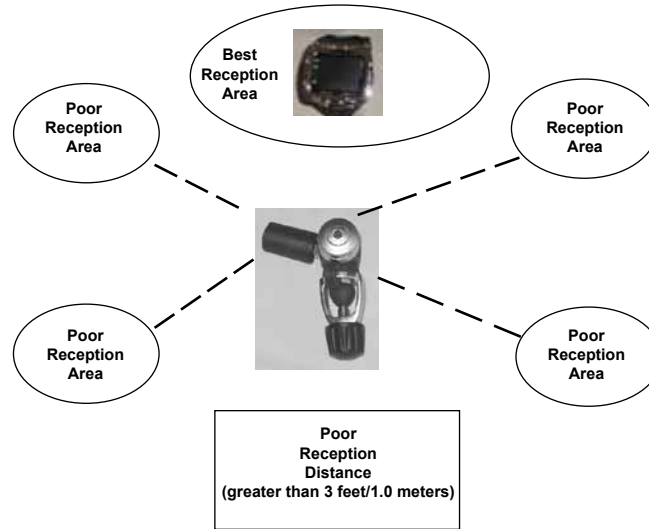

Fig. 33 - PREVIEW
(sample of selected items)



DIVE MODE FEATURES

TRANSMITTER SIGNAL RECEPTION GUIDE



PROXIMITY OF THE TMTs (Transmitters) AND VTX

The TMTs emit low frequency signals that radiate out in semicircular patterns parallel to the length dimension of the TMT. A coiled antenna inside the VTX receives the signals when it is positioned within a zone parallel to or at a 45 degree angle to the TMT as illustrated.

The VTX cannot effectively receive a signal when it is held out to the sides of the TMT or held at distances much greater than 3 feet (1.0 meters) in front of the TMT.

Best reception is achieved when the VTX is within less than 3 feet (1.0 meter) of the TMT and when Brightness is set for the lowest % possible.

When installed into the high pressure ports of the Regulator First Stages, the TMTs must be positioned so that they face horizontally outward from the Tank Valves.

Link Interruption Underwater

During a dive, you may at times move the VTX out of the signal pattern of the TMT, resulting in a temporary loss of the Link signal. The Link will be restored within 4 seconds after the VTX is moved back into its correct position.

An interruption may also occur while the VTX is within 3 feet (1 meter) of a running DPV, or shortly after a Strobe flashes. The Link will be restored within 4 seconds after the VTX is moved out of that area.

If the Link is not restored within 15 seconds, the Audible will sound during which the Pressure digits will flash (Fig. 34) until it is restored.

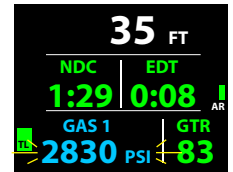

Fig. 34 - LOSS OF LINK

OVERVIEW OF AUTO DIM

The VTX is configured with a feature that automatically dims the screen to a lower level of brightness to conserve battery power when the screen is not being viewed during NORM or GAUG dives. It is not active during FREE dives.

To set the Time Until Dim (Off or min:sec) and Dim To Brightness (%) - refer to page 13, the Home Setup Menu.

When set Off, Auto Dim will have no affect on Brightness level that will be controlled by your adjustment of % desired.

When Auto Dim is set for a specific time and %, the Dive Mode screens will automatically dim to the % Brightness set after no button action for the min:sec Time that you set.

Pressing the S button momentarily (< 2 sec), while the screen is dim, will restore Brightness to the % level that you previously adjusted it to using the Adjust Brightness feature. Adjust as you wish as conditions require.

If an alarm strikes while the screen is dim, Brightness will restored to the % level that you previously adjusted it to.

If you adjust to a Brightness % that is lower than the Dim To value set, the screen will remain illuminated at your adjustment % (and Auto Dim will be disabled) until you adjust Brightness % to higher level which will enable Auto Dim once you are above the % level that was set for it.

WET ACTIVATION

The VTX is configured with contacts that will automatically activate Dive Mode when the space between the contacts is bridged by a conductive material (immersed in water) and it senses a Depth of 5 FT (1.5 M).

The contacts are the metal pins of the PC/Mac Interface Data Port and the stems of the buttons.

BAR GRAPHS

The VTX features 2 bar graphs, one on each side of the LCD (Fig. 35).

- > The one on the left represents nitrogen loading. It is referred to as the TLBG (Tissue Loading Bar Graph).
- > The one on the right represents ascent rate. It is referred to as the VARI (Variable Ascent Rate Indicator).

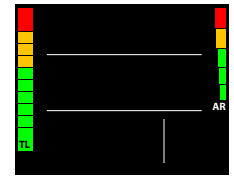

Fig. 35 - BAR GRAPHS

TLBG (TL)

The TLBG (on the left) represents your relative No Deco or Deco status. The lower (green & yellow) segments represent No Deco status and the top (red) segment indicates a Decompression condition. As your Depth and Elapsed Dive Time increase segments add, and as you ascend segments recede indicating that additional No Deco time is available.

The VTX monitors 12 different nitrogen compartments simultaneously and the TLBG displays the one that is in control of your dive at any given time.

VARI (AR)

The VARI (on the right) provides a visual representation of ascent speed (i.e., an ascent speedometer).

The segments represent two sets of speeds which change at a reference depth of 60 FT (18 M). Refer to the chart. When ascent is too fast, all segments of the VARI will flash until ascent is slowed.

60 FT (18 M) & Shallower			
VARI	Ascent Rate		
Segments	FPM	MPM	
0	0 - 10	0 - 3	
1	11 - 15	3.1 - 4.5	
2	16 - 20	4.6 - 6	
3	21 - 25	6.1 - 7.5	
4	26 - 30	7.6 - 9	
5	30 +	9 +	

Deeper than 60 FT (18 M)			
VARI	Ascent Rate		
Segments	FPM	MPM	
0	0 - 20	0 - 6	
1	21 - 30	6.1 - 9	
2	31 - 40	9.1 - 12	
3	41 - 50	12.1 - 15	
4	51 - 60	15.1 - 18	
5	60 +	18 +	

⚠ WARNING: At depths greater than 60 FT (18 M), ascent rates should not exceed 60 FPM (18 MPM). At depths of 60 FT (18 M) and shallower, ascent rates should not exceed 30 FPM (9 MPM).

ALGORITHM

The VTX is configured with 2 algorithms which allows you to choose which set of NDLs (No Deco Limits) will be used for Ni/O2 calculations and displays relating to Plan and DTR (Dive Time Remaining). The selection will lock until 24 hours elapse on the surface after the last dive, or all residual nitrogen has been offgassed (tissue desaturation time decreases to 0:00).

You can select DSAT or Z+. Refer to the NORM Set Utilities Menu (Fig. 36) to make sure the one desired is currently selected.

DSAT has been the standard used by Oceanic in almost all of its dive computers until this time. It features NDLs that are based on exposures and test data which also formed validation for the PADI RDP. It imposes restrictions for repetitive Deco dives, considered more risky.

Z+ (Pelagic Z+) performance is based on Buhlmann ZHL-16c. It features NDLs that are considerably more conservative, especially at shallower depths.

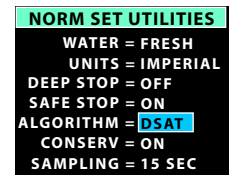

Fig. 36 - NORM SURF MAIN

To create even greater margins of safety with respect to decompression, a Conservative Factor as well as No Deco Deep and Safety Stops can be included for No Deco dives.

CONSERVATIVE FACTOR (CF)

When the CF is set ON, the NDLs which are based on the algorithm selected and used for Ni/O2 calculations and displays relating to Plan and DTR will be reduced to the values available at the altitude level that is 3,000 feet (915 meters) higher. Refer to the NDL charts in the back of this manual.

DEEP STOP (DS)

When the Deep Stop feature is set ON, it will trigger during NORM No Deco dives when you descend to 80 FT (24 M) and calculate (and continually update) a Stop Depth equal to 1/2 the Max Depth. An icon will be displayed on the NORM Dive Main screen (Fig. 37a) after it has triggered.

While 10 FT (3 M) deeper than the calculated Stop Depth, you will be able to access a DS Preview screen that will display the current Deep Stop Depth (calculated) and Time (fixed at 2 min) for 10 seconds then return to the Main.

Upon initial ascent to within 10 FT (3 M) below the calculated Stop Depth, a DS screen displaying a Stop Depth at 1/2 the Max Depth will appear with a Countdown Timer beginning at 2:00 (min:sec) and counting down to 0:00.

- > If you descend 10 FT (3 M) below, or ascend 10 FT (3 M) above, the calculated Stop Depth for 10 seconds during the countdown, the No Deco Main will replace the DS Main display and the DS feature will be disabled for the remainder of that dive. There is no Penalty if the DS is ignored.
- > In the event that you enter Deco, exceed 190 FT (57 M), or a High O2 condition (=> 80%) occurs, the DS will be disabled for the remainder of that dive.
- > The DS is disabled during a High PO2 Alarm condition (=> Set Point).

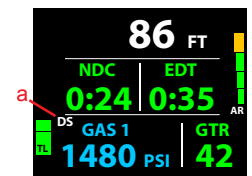

Fig. 37 - NORM DIVE MAIN

SAFETY STOP (SS)

If set ON:

Upon ascent to within 5 FT (1.5 M) deeper than the SS Depth set for 1 second on a No Deco dive in which Depth exceeded 30 FT (9 M) for 1 second, a beep will sound and a SS at the Depth set will appear on the Main display with a countdown beginning at the SS Time set and counting down to 0:00 (min:sec).

- If the SS was set for OFF or TIMER, this display will not appear.
- In the event that you descend 10 FT (3 M) deeper than the Stop Depth for 10 seconds during the countdown, or the countdown reaches 0:00, the No Deco Main screen will replace the SS Main screen which will reappear upon ascent to within 5 FT (1.5 M) deeper than the Safety Stop Depth set for 1 second.
- In the event that you enter Deco during the dive, complete the Deco obligation, then descend below 30 FT (9 M); the SS Main will appear again upon ascent to within 5 FT (1.5 M) deeper than the SS Depth set for 1 second.
- If you surface prior to completing the SS, it will be disabled for the remainder of that dive.
- There is no Penalty if you surface prior to completing the SS or ignore it.

DIVE TIME REMAINING (DTR)

The VTX constantly monitors nitrogen loading and oxygen accumulation, and will display whichever time is the least amount available as DTR on the No Deco Dive Main screen (Fig. 38a). The graphic NDC, or OTR, will identify which time is being displayed.

No Deco DTR (NDC)

NDC is the maximum amount of time that you can stay at your present Depth before entering Deco. It is calculated based on the amount of Nitrogen absorbed by hypothetical tissue compartments. The rates each of these compartments absorb and release Nitrogen is mathematically modeled and compared against a maximum allowable Nitrogen level.

Whichever one is closest to this maximum level is the controlling compartment for that Depth. Its resulting value will be displayed as NDC time and graphically as the TLBG.

As you ascend, the TLBG segments will recede as control shifts to slower compartments. *This is a feature of the decompression model that is the basis for multilevel diving, one of the most important advantages that Oceanic dive computers offer.*

O2 Time Remaining (OTR)

During Nitrox operation, O2 accumulation during a dive, or 24 hour period, is displayed as a percent of O2 saturation allowed per dive or per day. Max allowed (100%) is 300 OTU.

When time remaining before reaching the O2 limit becomes less than NDC, calculations for that Depth will be controlled by O2 and OTR will be displayed as DTR on the Dive Main.

GAS TIME REMAINING (GTR)

GTR is calculated using a patented algorithm that is based on a diver's individual Air (Gas) Consumption Rate and Current Depth. Tank Pressure is measured once each second and an average rate of Consumption is calculated over a 90 second period. This Rate of Consumption is then used in conjunction with the Depth to predict the Air (Gas) required for the diver to make a safe controlled Ascent including the No Deco Deep and Safety Stops and any required Deco Stops.

Air (Gas) Consumption and Depth are continuously monitored and GTR reflects any change in circumstances. For example, when you suddenly find yourself swimming against a strong current and begin breathing more rapidly, the VTX will recognize the change and adjust GTR accordingly.

GTR is the time you can remain at the present Depth and still safely surface with the Tank Pressure reserve that you selected during setup (End Pressure Alarm Setting).

GTR is displayed on the Dive Main screens (Fig. 38b).

GTR Alarm

When GTR decreases to 5 minutes, the Audible will sound and the GTR time digits and graphic will flash yellow (Fig. 39). If it decreases to 0, the Audible will sound again. The time digits and graphic will continue to flash red until GTR becomes greater than 1 minute, then it will flash yellow until greater than 5 minutes.

You should initiate a controlled Ascent while monitoring Tank Pressure. However, there is no reason to panic, the VTX has allowed for the air necessary for a safe ascent including the No Deco Deep and Safety Stops, if set On, and any Deco Stops required.

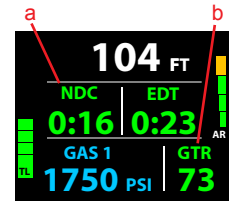

Fig. 38 -NO DECO MAIN (NDC is DTR)

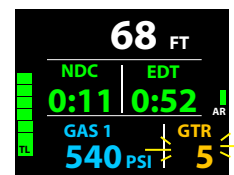

Fig. 39 - NO DECO MAIN (GTR 5 min warning)

NORM DIVE MODE

NO DECO MAIN, information includes** (Fig. 40A/B):

- > Current Depth with FT (or M) icon.
- > Dive Time Remaining (hr:min) with NDC (or OTR) icon.
- > Graphic GAS 1 (or 2, 3, 4), one in use.
- > Pressure with PSI (or BAR) icon, if the Receiver and Transmitter are active, flashing when Link is lost; or graphic SPG when no Transmitter is in use (SPG = Submersible Pressure Gauge).
- > Gas Time Remaining (min) with icon, up to 99 (remains at 99 when greater), blank if SPG.
- > DS icon - if Deep Stop is set ON and has triggered (activated).
- > TLBG (TL), VARI (AR) - if they apply.
- > Low Battery icon - yellow (if voltage is at the warning level), or red flashing (if voltage is at the alarm level).

- A (2 sec) - to access Adjust Brightness.
- A (< 2 sec) - to access ALT.
- M (2 sec) - to access the Gas/TMT Switch Menu*.
- M (< 2 sec) - to apply a snapshot Earmark to the PCI data recorded at that time. *The graphics EARMARK APPLIED will be displayed in place of NDC for 3 seconds (Fig. 40C).*
- S (< 2 sec) - to restore screen Brightness from the Auto Dim level to the % level you last adjusted it to.
- S (< 2 sec) - to acknowledge alarms; this will also restore screen Brightness if it was dimmed by Auto Dim.
- S (2 sec) - to access Compass*.

*These items can only be accessed while viewing the Main.

ADJUST BRIGHTNESS, information includes (Fig. 41):

- > xx % (last value saved). *Up to 60% max when Low Battery Warning or Alarm.*
- S (2 sec) - to step back to the Main without changing the value.
- A (< 2 sec) - to step upward through values of 10% to 100% one at a time in increments of 10%.
- M (< 2 sec) - to step down through values one at a time.
- S (< 2 sec) - to save the % setting and revert to the Main.
- Revert to Main in 10 sec, if no button is pressed.

NO DECO ALT, information includes (Fig. 42):

- > MAX D = xxx FT (or xx.x M).
- > TIME = hr:min with AM (or PM) if 12 Hour Format.
- > TEMP = xx F (or C).
- > GAS 1 (or 2, 3, 4) = AIR; or FO2 % set with PO2 Alarm setting.
- > PO2 = x.xx (current level).
- > O2 SAT = xx % (current level of saturation).
- A (< 2 sec) - to access DS Preview if On and triggered, or revert to Main.
- M (< 2 sec) - to step back to Main.
- Revert to Main in 10 sec, if no button is pressed.

DEEP STOP (DS) PREVIEW (if On and triggered), information includes (Fig. 43):

- > Current Depth with FT (or M) icon.
- > Graphic DEEP STOP with Stop icon (arrows and bar).
- > Stop Depth with FT (or M) icon and countdown Time as 2:00 (min:sec).
- A (< 2 sec) - to revert to Main.
- M (< 2 sec) - to step back to ALT.
- Revert to Main in 10 sec, if no button is pressed.

DEEP STOP (DS) MAIN, information includes (Fig. 44A):

- > Current Depth with FT (or M) icon.
- > Graphic DEEP STOP with Stop icon (arrows and bar).
- > Stop Depth with FT (or M) icon and countdown Time (min:sec).
- > Graphic GAS 1 (or 2, 3, 4), one in use.
- > Pressure with PSI (or BAR) icon, if the Receiver and Transmitter are active, flashing when Link is lost; or graphic SPG.
- > Gas Time Remaining (min) with icon, up to 99 (remains at 99 when greater), blank if SPG.
- > TLBG (TL), VARI (AR) - if they apply.
- > Low Battery icon - yellow (if voltage is at the warning level), or red flashing (if voltage is at the alarm level).
- A (2 sec) - to access Adjust Brightness.
- A (< 2 sec) - to access DS ALT (similar to No Deco ALT).
- M (2 sec) - to access the Gas/TMT Switch Menu*.
- M (< 2 sec) - to apply a snapshot Earmark to the PCI data recorded at that time. *The graphics EARMARK APPLIED will be displayed in place of Stop information for 3 seconds (Fig. 44B).*
- S (< 2 sec) - to restore screen Brightness from the Auto Dim level to the % level you last adjusted it to.
- S (< 2 sec) - to acknowledge alarms; this will also restore screen Brightness if it was dimmed by Auto Dim.
- S (2 sec) - to access Compass*.

*These items can only be accessed while viewing the Main.

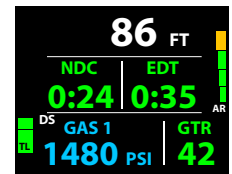

Fig. 40A - NO DECO MAIN (FO2 set for Nitrox)

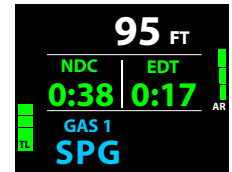

Fig. 40B - NO DECO MAIN (no Transmitters in use)

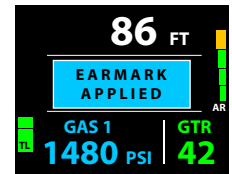

Fig. 40C - NO DECO MAIN (during 3 sec message)

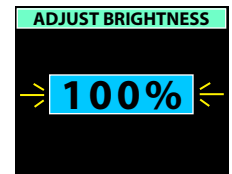

Fig. 41 - BRIGHTNESS

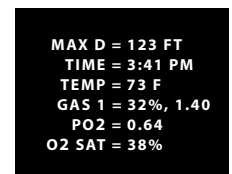

Fig. 42 - NO DECO ALT



Fig. 43 - DS PREVIEW

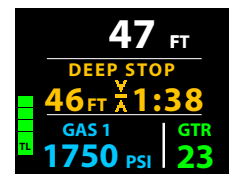

Fig. 44A - DS MAIN

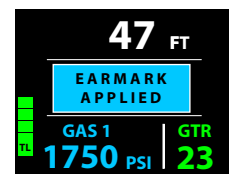

Fig. 44B - DS MAIN (during 3 sec message)

SAFETY STOP (SS) MAIN, information includes (Fig. 45):

- > Current Depth with FT (or M) icon.
- > Graphic SAFETY STOP with Stop icon (arrows and bar).
- > Stop Depth with FT (or M) icon & countdown Time (min:sec).
- > Graphic GAS 1 (or 2, 3, 4), one in use.
- > Pressure with PSI (or BAR) icon, if the Receiver and Transmitter are active, flashing when Link is lost; or graphic SPG.
- > Gas Time Remaining (min) with icon, up to 99 (remains at 99 when greater), blank if SPG.
- > TLBG (TL).
- > Low Battery icon - yellow (if voltage is at the warning level), or red flashing (if voltage is at the alarm level).

- A (2 sec) - to access Adjust Brightness.
- A (< 2 sec) - to access SS ALT (similar to No Deco ALT).
- M (2 sec) - to access the Gas/TMT Switch Menu*.
- M (< 2 sec) - to apply a snapshot Earmark to the PCI data recorded at that time. *The graphics EARMARK APPLIED will be displayed in place of Stop information for 3 seconds (Fig. 46).*
- S (< 2 sec) - to restore screen Brightness from the Auto Dim level to the % level you last adjusted it to.
- S (< 2 sec) - to acknowledge alarms; this will also restore screen Brightness if it was dimmed by Auto Dim.
- S (2 sec) - to access Compass*.

**These items can only be accessed while viewing the Main.*

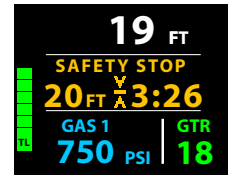

Fig. 45 - SS MAIN (Stop Depth/Time set ON)

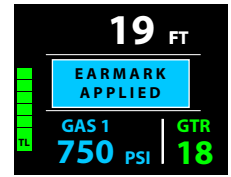

Fig. 46 - SS MAIN (during 3 sec message)

DECOMPRESSION

Decompression mode activates when theoretical No Decompression time and depth limits are exceeded.

Upon entry into Deco (Fig. 47), the Audible will sound for 10 seconds* during which the graphic DECO ENTRY (red) will flash. A Stop Bar with Up Arrow icon (red) will also flash until within 10 FT (3 M) of and below the required Stop Depth (the Stop Zone) which is also displayed with the required Stop Time (both red).

*S (< 2 sec) - to silence the Audible during the 10 seconds.

- > Once within 10 FT (3 M) of and below the required Stop Depth (the Stop Zone), the full Stop icon (Up & Down Arrows with Stop Bar) will be displayed solid (yellow).

Managing Deco Stops

To fulfill your decompression obligation, you should make a safe controlled Ascent to a depth slightly deeper than, or equal to, the required Stop Depth indicated and decompress for the Stop Time indicated.

The amount of decompression credit time that you receive is dependent on Depth, with slightly less credit given the deeper you are below the Stop Depth indicated.

You should stay slightly deeper than the required Stop Depth indicated until the next shallower Stop Depth appears. Then, you can slowly ascend to, but not shallower than that indicated Stop Depth.

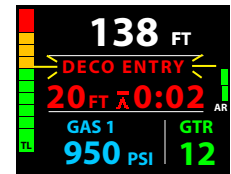

Fig. 47 - DECO ENTRY

DECO STOP MAIN, information includes (Fig. 48A):

- > Current Depth with FT (or M) icon.
- > Graphic DECO STOP with Stop icon (arrows and bar).
- > Stop Depth with FT (or M) icon and countdown Time (min:sec).
- > Graphic GAS 1 (or 2, 3, 4), one in use.
- > Pressure with PSI (or BAR) icon, if the Receiver and Transmitter are active, flashing when Link is lost; or graphic SPG.
- > Gas Time Remaining (min) with icon, up to 99 (remains at 99 when greater), blank if SPG.
- > Full TLBG (TL), red indicates that status is Deco.
- > Low Battery icon - yellow (if voltage is at the warning level), or red flashing (if voltage is at the alarm level).

- A (2 sec) - to access Adjust Brightness.
- A (< 2 sec) - to access ALT.
- M (2 sec) - to access the Gas/TMT Switch Menu*.
- M (< 2 sec) - to apply a snapshot Earmark to the PCI data recorded at that time. *The graphics EARMARK APPLIED will be displayed in place of Stop information for 3 seconds (Fig. 48B).*
- S (< 2 sec) - to restore screen Brightness from the Auto Dim level to the % level you last adjusted it to.
- S (< 2 sec) - to acknowledge alarms; this will also restore screen Brightness if it was dimmed by Auto Dim.
- S (2 sec) - to access Compass*.

**These items can only be accessed while viewing the Main.*

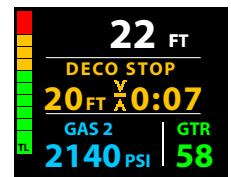

Fig. 48A - DECO STOP MAIN

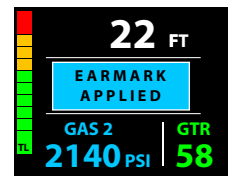

Fig. 48B - DECO STOP MAIN (during 3 sec message)

DECO STOP ALT, information includes (Fig. 49):

- > TAT = hr:min (up to 9:59).
- > EDT = hr:min (up to 9:59).
- > MAX D = xxx FT (or xx.x M).
- > TIME = hr:min with AM (or PM) if 12 Hour Format.
- > TEMP = xx F (or C).
- > GAS 1 (or 2, 3, 4) = AIR; or FO2 % set with PO2 Alarm setting.
- > PO2 = x.xx (current level).
- > O2 SAT = xx % (current level of saturation).

TAT = Total Ascent Time to the surface including all stops.

- A or M (< 2 sec) - to step back to Main.
- Revert to Main in 10 sec, if no button is pressed.

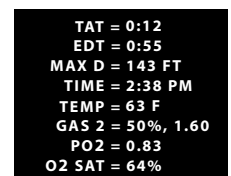

Fig. 49 - DECO STOP ALT

CONDITIONAL VIOLATION (CV)

Upon ascent above the required Deco Stop Depth, operation will enter CV during which no off gassing credit will be given, meaning Deco Stop Time and TAT will not decrease. A penalty time of 1 1/2 minutes will be added for each minute above the required Stop Depth.

The Audible will sound for 10 seconds during which the full TLBG will flash. The graphics DOWN TO STOP with down arrow & stop bar icon, and Stop Depth & Time, all red, will flash (Fig. 50) until descent is made to below the required Stop Depth, then the Deco Stop Main will be displayed.

- S (< 2 sec) - to silence Audible.
- > Other button operations and displays are similar to Deco.

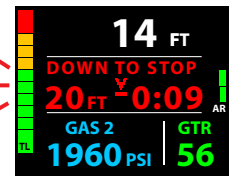

Fig. 50 - CV MAIN

If descent below the required Deco Stop Depth is made within 5 minutes, operation will resume in Deco with off gassing credit given (Stop Time and TAT will decrease).

DELAYED VIOLATION 1 (DV1)

Once above the Deco Stop Depth for more than 5 minutes, operation will enter DV1 which is a continuation of CV*.

*The difference between DV1 and CV is that DV1 causes operation to enter Violation Gauge Mode (VGM) 5 minutes after surfacing from that dive.

The Audible, which cannot be silenced by pressing S, will sound for 10 seconds. The graphics DOWN TO STOP with down arrow & stop bar icon, and Stop Depth & Time, all red, will flash (Fig. 51) until descent is made to below the required Stop Depth, then the Deco Stop Main will be displayed.

- > Button operations and displays are similar to Deco.

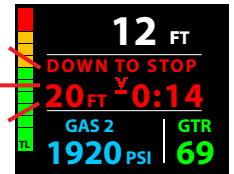

Fig. 51 - DV1 MAIN

When descent below the required Deco Stop Depth is made, operation will resume in Deco with off gassing credit given (Stop Time and TAT will decrease).

DELAYED VIOLATION 2 (DV2)

If the calculated Deco obligation requires a Stop Depth between 60 FT (18 M) and 70 FT (21 M), operation will enter DV2.

Upon entry into DV2*, the Audible will sound during which the full TLBG will flash.

*The difference between DV2 and general Deco is that DV2 causes operation to enter VGM 5 minutes after surfacing from that dive.

- > Once within 10 FT (3 M) of and below the required Stop Depth, the full Stop icon (Arrows with Stop Bar) will be displayed solid (Fig. 52).
- > Button operations and displays are similar to Deco.

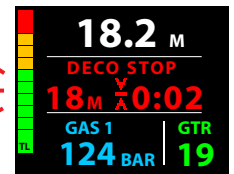

Fig. 52 - DV2 MAIN

DELAYED VIOLATION 3 (DV3)

Upon descent deeper than the 330 FT (100 M)*, the Audible will sound for 10 seconds.

*Beyond this depth, the VTX cannot accurately perform calculations and display data.

Upon ascending above 330 FT (100 M), Current Depth will be restored, however, Max Depth will display 3 dashes for the remainder of that dive. Also, the Log for that dive will display 3 dashes as the Max Depth.

DV3 MAIN, information includes (Fig. 53) -

- > Current Depth as dashes (---) with FT (or M) icon.
- > Graphics GO UP TOO DEEP with Up Arrows (red), flashing.
- > Graphic GAS 1 (or 2, 3, 4), one in use.
- > Pressure with PSI (or BAR) icon, if the Receiver and Transmitter are active, flashing when Link is lost; or graphic SPG.
- > Gas Time Remaining (min) with icon, blank if SPG.
- > TLBG (TL), VARI (AR) while ascending.
- > Low Battery icon - yellow (if voltage is at the warning level), or red flashing (if voltage is at the alarm level).

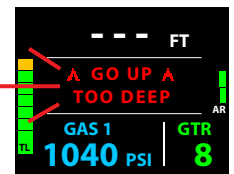

Fig. 53 - DV3 MAIN

- A (2 sec) - to access Adjust Brightness.
- A (< 2 sec) - to access ALT.
- M (2 sec) - to access the Gas/TMT Switch Menu*.
- S (< 2 sec) - to restore screen Brightness from the Auto Dim level to the % level you last adjusted it to.
- S (< 2 sec) - to acknowledge alarms; this will also restore screen Brightness if it was dimmed by Auto Dim.
- S (2 sec) - to access Compass*.

*These items can only be accessed while viewing the Main.

VIOLATION GAUGE MODE (VGM)

If a Deco Stop Depth greater than 70 FT (21 M) is required, operation will enter VGM. This would be preceded by DV2.

Operation would then continue in VGM during the remainder of that dive and for 24 hours after surfacing.

VGM turns the VTX into a digital instrument without any decompression or oxygen related calculations or displays.

Upon activation of VGM, the Audible will sound for 10 seconds during which full TLBG* will flash, then be removed.

VGM MAIN, information includes (Fig. 54) -

- > Current Depth with FT (or M) icon.
- > Graphics GO UP VIOLATION with 2 Up Arrows (red), flashing until on surface.
- > Graphic GAS 1 (or 2, 3, 4), one in use.
- > Pressure with PSI (or BAR) icon.
- > GTR (min) with icon.
- > Full TLBG, flashing during Audible, then removed.
- > VARI while ascending.
- > Low Battery icon - yellow (if voltage is at the warning level), or red flashing (if voltage is at the alarm level).

- A (2 sec) - to access Adjust Brightness.
- A (< 2 sec) - to access ALT.
- M (2 sec) - to access the Gas/TMT Switch Menu*.
- S (< 2 sec) - to restore screen Brightness from the Auto Dim level to the % level you last adjusted it to.
- S (< 2 sec) - to acknowledge alarms; this will also restore screen Brightness if it was dimmed by Auto Dim.
- S (2 sec) - to access Compass*.

**These items can only be accessed while viewing the Main.*

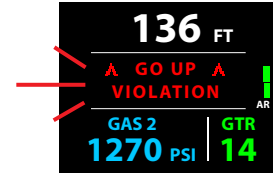

Fig. 54 - VGM MAIN (after Audible)

VGM ALT information is similar to the Deco ALT.

VGM ON SURFACE

The graphic VIOL flashes for the first 10 minutes, then VIOL (Fig. 55) alternates with NORM (each On 3 seconds) until unit shut down after 24 hours with no dives*.

**A full 24 hour surface interval must then be served before all functions are restored.*

During that 24 hours, access to all menus and screens is available except those associated with Ni-O2 calculations such as Plan, Set FO2. The Fly countdown timer provides the time remaining (of the 24 hours required) before normal operation can resume with full features and functions.

Operation also enters VGM 5 minutes after surfacing from a dive in which a Delayed Violation occurred or O2 reached 100%.

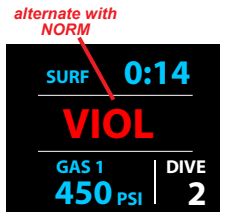

Fig. 55 - VGM ON SURFACE

HIGH PO2

Warning >> at 0.20 less than the alarm value set for the Gas in use.

Alarm >> at the value set for the Gas in use, except in Deco then at 1.60 only.

When partial pressure of oxygen (PO2) increases to the Warning level; the Audible will sound during which the graphics PO2 = 1.xx (yellow) will flash in place of DTR (Fig. 56A).

After the Audible is silenced, DTR is restored.

If PO2 continues to increase and reaches the PO2 Alarm level set for the gas in use, the Audible will sound again during which the graphics GO UP PO2 = 1.xx with Up Arrows (red) will flash in place of DTR* (Fig. 56B) until PO2 decreases below the set point at which time DTR will be restored.

**DTR moves to the ALT screen.*

- A (2 sec) - to access Adjust Brightness.
- A (< 2 sec) - to access ALTs.
- M (2 sec) - to access the Gas/TMT Switch Menu*.
- S (< 2 sec) - to restore screen Brightness from the Auto Dim level to the % level you last adjusted it to.
- S (< 2 sec) - to acknowledge alarms; this will also restore screen Brightness if it was dimmed by Auto Dim.
- S (2 sec) - to access Compass*.

**These items can only be accessed while viewing the Main.*

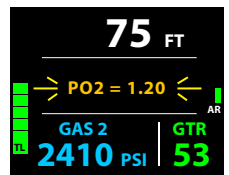

Fig. 56A - PO2 WARNING (No Deco Dive Main)

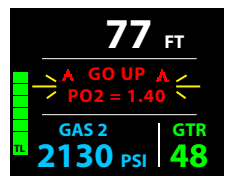

Fig. 56B - PO2 ALARM (No Deco Dive Main)

PO2 during Deco

The PO2 alarms that were set do not apply when in Deco.

If PO2 reaches 1.60, the Audible will sound during which the graphics PO2 = 1.60 (red) will flash in place of Stop Depth/Time (Fig. 56C).

After the Audible is silenced, the PO2 graphics will alternate with Stop Depth/Time once each minute*.

**PO2 graphics will be displayed for 10 seconds, then Stop Depth/Time will be displayed for 50 seconds once each minute until PO2 decreases below 1.60, then PO2 will not be displayed.*

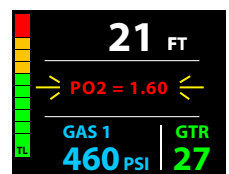

Fig. 56C - PO2 ALARM (Deco Stop Main)

HIGH O2

Warning >> at 80 to 99% (240+ OTU).
Alarm >> at 100% (300+ OTU).

When O2 reaches the Warning level; the Audible will sound during which the graphics O2SAT = 80% (yellow) will flash in place of DTR (Fig. 57A). After the audible is silenced, DTR will be restored.

If O2 reaches the Alarm level; the Audible will sound again during which the graphics GO UP O2 = 100% with Up Arrows (red) will flash (Fig. 57B). After the Audible is silent, the graphics will remain on solid until on the surface.

- A (2 sec) - to access Adjust Brightness.
- A (< 2 sec) - to access ALTs.
- M (2 sec) - to access the Gas/TMT Switch Menu*.
- S (< 2 sec) - to restore screen Brightness from the Auto Dim level to the % level you last adjusted it to.
- S (< 2 sec) - to acknowledge alarms; this will also restore screen Brightness if it was dimmed by Auto Dim.
- S (2 sec) - to access Compass*.

**These items can only be accessed while viewing the Main.*

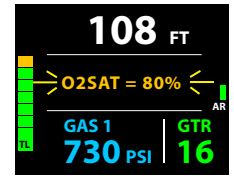

Fig. 57A - O2 WARNING (No Deco Dive Main)

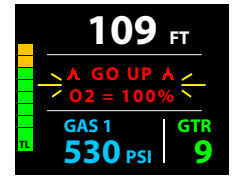

Fig. 57B - O2 ALARM (No Deco Dive Main)

High O2 during Deco

When O2 reaches the Warning Level; the Audible will sound during which the graphics O2SAT = xx% (yellow) will flash in place of Stop Depth/Time (Fig. 57C) until the Audible is silenced, then Stop Depth/Time will be restored. *No indication is given to ascend.*

When O2 reaches 100%, the Audible will sound again during which the graphics GO UP O2 = 100% with Up Arrows (red) will flash until on the surface (Fig. 57D). After the Audible is silent, the graphics will remain on solid until on the surface. *The full TLBG remains on solid as a reminder of Deco.*

- A (2 sec) - to access Adjust Brightness.
- A (< 2 sec) - to access ALTs.
- M (2 sec) - to access the Gas/TMT Switch Menu*.
- S (< 2 sec) - to restore screen Brightness from the Auto Dim level to the % level you last adjusted it to.
- S (< 2 sec) - to acknowledge alarms; this will also restore screen Brightness if it was dimmed by Auto Dim.
- S (2 sec) - to access Compass*.

**These items can only be accessed while viewing the Main.*

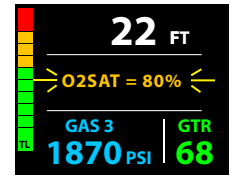

Fig. 57C - O2 WARNING (Deco Stop Main)

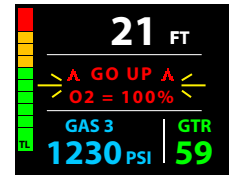

Fig. 57D - O2 ALARM (Deco, until on surface)

High O2 on Surface

Upon ascent to 2 FT (0.6 M) for 1 second (surfacing), the Surface Main screen is displayed. During the first 10 minutes, access to the Surface ALTs is allowed with other modes and screens blocked until the 10 minutes elapse.

- > If O2 is 100%, the value graphics O2 = 100% will flash on the Main (Fig. 57E) in place of the graphic NORM until 10 minutes elapse, then the graphics will alternate until O2 is < 100% when O2 will be removed.
- > If you surface due to 100% O2 without having completed the Deco obligation, operation will enter VGM after 5 minutes.

alternate with NORM

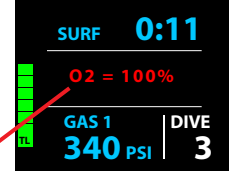
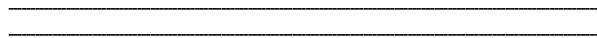

Fig. 57E - O2 ALARM (on surface)



GAS/TMT SWITCHING

OVERVIEW

- > Can only switch when a Dive Main screen is displayed.
- > Cannot Switch Gas or TMTs on surface, except during the first 10 minutes after surfacing from a dive.
- > Cannot Switch Gas or TMTs during sounding of alarms.
- > All NORM dives begin with Gas 1 and default to Gas 1 after 10 minutes on the surface.
- > Switching Gas also switches TMTs, if being used.

The following will describe NORM GAS/TMT Switching, then GAUG TMT Switching.

NORM GAS SWITCH MENU, information includes (Fig. 58A):

While a Dive Main is displayed, press M (2 sec) - to access the Menu.

- > Left column labeled GAS - lists them as 1, 2, 3, 4.
 - > Middle column labeled FO2 - lists the settings (AIR, % if Nitrox, or NONE if not set for use).
 - > Right column labeled EXPECT PO2 - lists the value o expect based on current calculations.
- A (< 2 sec) - to step forward (down) through & highlight Gas selections
 - M (< 2 sec) - to step back (up) through selections.
 - S (< 2 sec), while a Gas is highlighted - to flash that Gas allowing it to be selected.
 - S (< 2 sec) again, while a Gas is highlighted & flashing - to switch to that Gas and revert to the Dive Main with it selected.
 - M (2 sec), at any time - to exit and revert to the Dive Main without switching to a new Gas.
 - No button action for 10 seconds will exit and revert to the Dive Main without switching to a new Gas.

GAS SWITCH MENU		
GAS	FO2	EXPECT PO2
1	= AIR	0.44
2	= 32%	0.66
3	= 80%	1.33
4	= NONE	

Fig. 58A - NORM GAS MENU

If the associated TMT is set On, the message Searching for TMTx (Fig. 58B), or TMTx Not Available (Fig. 58C), will be displayed for 10 seconds, then operation will revert to the Dive Main with that Gas & TMT selected for use.

If the Gas/TMT are not switched to the same source (tank) as the gas being breathed, GTR will increase to maximum after 1 minute without a change in transmitted Pressure.

Gas Switch Alarm

If a switch to the Gas would result in PO2 => 1.60, the Audible will sound and a warning message will flash (Fig. 58D) until it is silenced, then the Switch Menu screen will be restored.

- > Due to the possibility that sufficient air may not be available in the Switch From tank, the switch will still be allowed.
- > If the switch is made, the PO2 alarm will strike. If in Deco, indication to ascend will not be given (you control action to be taken).



Fig. 58B - TMT SEARCH



Fig. 58C - TMT NOT REPORTING

GAUG TMT SWITCH MENU, information includes (Fig. 58E):

While a Dive Main is displayed, press M (2 sec) - to access the Menu.

- > Single column - lists only TMTs set for use (1, 2, 3, 4).
- A (< 2 sec) - to step forward (down) through & highlight selections.
 - M (< 2 sec) - to step back (up) through selections.
 - S (< 2 sec), while a TMT is highlighted - to flash that TMT allowing it to be selected.
 - S (< 2 sec) again, while a TMT is highlighted & flashing - to the message Searching for TMTx (Fig. 58B), or TMTx Not Available (Fig. 58C) for 10 seconds, switch to that TMT, and revert to the Dive Main with it selected.
 - M (2 sec), at any time - to exit and revert to the Dive Main without switching to a new TMT.
 - No button action for 10 seconds will exit and revert to the Dive Main without switching to a new TMT.

If the TMT is not switched to the same source (tank) as the one being breathed from, GTR will increase to maximum after 1 minute without a change in transmitted Pressure.

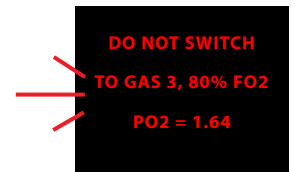

Fig. 58D - GAS SWITCH ALARM

TMT SWITCH MENU
TMT 1
TMT 2
TMT 3

Fig. 58E - GAUG TMT MENU

GAUG OP MODE

GAUG SURFACE MODE

The Surface Main screen will remain on display for 10 minutes during which time the unit will enter Dive Mode upon descent to 5 FT (1.5 M) for 5 seconds. If 10 minutes elapses with no button action, operation will enter Power Saver Mode (PSM).

Operation will enter Post Dive Surface Mode upon ascent to 2 FT (0.6 M) for 1 second and display the Surface Main with the SURF icon flashing.

Access to Surface Alternate screens is allowed during the first 10 minutes with access to other surface modes/screens blocked until 10 minutes elapse.

When the 10 minute post dive surface Interval time has elapsed, access to other Surface modes/screens is allowed. If another 2 minutes of no action elapses, operation will enter PSM turning the screen off until a button is pressed.

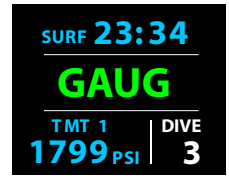

Fig. 59A - GAUG SURF MAIN (post dive)

GAUG SURF MAIN, information includes (Fig. 59A/B):

- > Surface Interval Time (hr:min, colon flashing), with SURF icon (flashing during first 10 min after surfacing).
- > Graphic GAUG.
- > Graphic TMT 1 (start TMT & default 10 minutes after a dive), TMT in use during first 10 min after surfacing.
- > Tank 1 Pressure with PSI (or BAR) icon (start TMT & default TMT 10 minutes after a dive), graphic SPG (meaning Submersible Pressure Gauge) if no TMT is in use; TMT in use during first 10 min after surfacing.
- > Graphic DIVE with number of the dive just completed (up to 24), 0 if no dive yet (or 2 dashes - - with GTR icon during first 10 min after surfacing).
- > Low Battery icon - yellow (if voltage is at the warning level), or red flashing (if voltage is at the alarm level).

- A (2 sec) - to access the Adjust Brightness screen.
- A (< 2 sec) - to access SURF ALT 1.
- M (2 sec) - to revert to the Home Menu.
- M (< 2 sec) - to access the GAUG Menu.
- S (2 sec) - to access the Compass OP Main.



Fig. 59B - GAUG SURF MAIN (post dive, no Transmitters)

ADJUST BRIGHTNESS, information includes (Fig. 60):

- > xx % (last value saved). Up to 60% max when Low Battery Warning or Alarm.

- S (2 sec) - to step back to the Main without changing the value.
- A (< 2 sec) - to step upward through values of 10% to 100% one at a time in increments of 10%.
- M (< 2 sec) - to step down through values one at a time.
- S (< 2 sec) - to save the % setting and revert to the Main.
- Revert to Main in 10 sec, if no button is pressed.

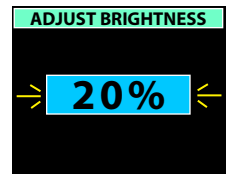

Fig. 60 - BRIGHTNESS CONTROL

GAUG SURF ALT 1, information includes (Fig. 61):

- > LAST DIVE (screen title).
- > xxx FT (or xx.x M) with graphic MAX DEPTH.
- > Elapsed Dive Time (hr:min, up to 9:59) with graphic DIVE TIME.

- A (< 2 sec) - to access SURF ALT 2.
- M (< 2 sec) - to step back to the SURF MAIN.
- 10 sec with no button action, revert to the SURF MAIN.



Fig. 61 - GAUG SURF ALT 1

GAUG SURF ALT 2, information includes (Fig. 62):

- > DATE = m.d.y (or d.m.y).
- > TIME = hr:min with AM (or PM) if 12 Hour Format.
- > TEMP = xx F (or C).
- > ELEV = SEA (or EL2 to EL7).
- > FLY = hr:min*

- A (< 2 sec) - to revert to SURF MAIN.
- M (< 2 sec) - to step back to SURF ALT 1.
- 10 sec with no button action, revert to SURF MAIN.



Fig. 62 - GAUG SURF ALT 2

*The Time to Fly counter will begin counting down from 23:50 to 0:00 (hr:min) 10 minutes after surfacing from any dive.

GAUG MENU, information includes (Fig. 63):

- > SET TMTS - to access a menu for setting transmitters.
- > SET ALARMS - to access a menu for setting dive alarms.
- > SET UTILITIES - to access a menu for setting dive related functions such as algorithm, stops, etc.
- > VIEW PREVIEW - to view items.

- A (< 2 sec) - to step forward (down screen) through Menu selections (the active item highlighted).
- M (< 2 sec) - to step back (up screen) through Menu selections.
- S (< 2 sec) - to access the selection that is highlighted.
- M or S (2 sec) - to step back from the Menu to the SURF MAIN.
- M (2 sec) - to exit the Menu system and revert to the SURF MAIN.
- No button action (for 2 min) - will exit the Menu system and revert to the SURF MAIN.



Fig. 63 - GAUG MENU

SET TMT MENU (NORM, GAUG), previously described on page 19.

SET ALARMS MENU (GAUG), information includes (Fig. 64):

Selections with their last Set points saved include:

- > AUDIBLE = with ON or OFF.
- > DEPTH = with OFF, or 30 to 330 FT (or 10 to 100 M), increments of 10 FT (3 M).
- > EDT = with OFF, or 0:10 to 3:00 (hr:min), increments of :05. *EDT is Elapsed Dive Time.*
- > TURN = with OFF, or 1000 to 3000 PSI (or 70 to 205 BAR), increments of 250 PSI (5 BAR). *TURN is pressure of TMT 1.*
- > END = with 300 to 1500 PSI (or 20 to 105 BAR), increments of 100 PSI (5 BAR). *END is pressure of the TMT in use.*

- A (< 2 sec) - to step forward (down screen) through and highlight Menu selections.
- M (< 2 sec) - to step back (up screen) through Menu selections.
- S (< 2 sec), when a selection is highlighted - to highlight & flash that item's set point.

- A (< 2 sec) - to toggle or increase the set point.
- A (hold) - to increase the set point at a rate of 8 per second.
- M (< 2 sec) - to toggle or decrease the set point.
- S (< 2 sec) - to save the setting and revert to the Set Alarms Menu.

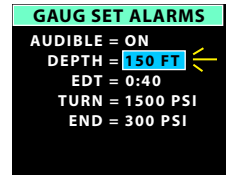

Fig. 64 - SET ALARMS

SET UTILITIES MENU (GAUG), information includes (Fig. 65):

Selections with their last Set points saved include:

- > WATER = with FRESH or SEA. *Depth values will be based on the type of water.*
- > UNITS = with IMPERIAL or METRIC.
- > SAMPLING = with 2, 15, 30, or 60 SEC (second). *Rate that data is sampled and recorded for PC download.*

Additional information relating to the effects of the items included are described in associated sections throughout this manual.

- A (< 2 sec) - to step forward (down screen) through and highlight Menu selections.
- M (< 2 sec) - to step back (up screen) through Menu selections.
- S (< 2 sec), when a selection is highlighted - to highlight & flash that item's set point.

- A (< 2 sec) - to toggle or increase the set point.
- A (hold) - to increase the set point at a rate of 8 per second.
- M (< 2 sec) - to toggle or decrease the set point.
- S (< 2 sec) - to save the setting and revert to the Set Utilities Menu.

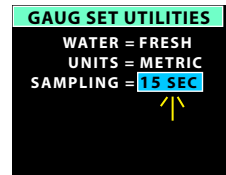

Fig. 65 - SET UTILITIES

GAUG DIVE PREVIEW, information includes (Fig. 66):

Upon accessing this screen from the GAUG MENU, the items illustrated will be displayed with the settings last saved.

Turn and End Alarms will not be displayed unless a TMT is in use.

- S or M (2 sec) to step back to the GAUG MENU with VIEW PREVIEW highlighted.

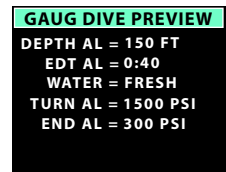

Fig. 66 - VIEW PREVIEW

GAUG DIVE MAIN, information includes (Fig. 67):

Either Elapsed Dive Time (EDT) or a Run Time can be displayed on the Main screen with the other on the ALT (Alternate) screen.

- > Current Depth with FT (or M) icon.
- > Graphic RUN with Run Time (up to 9:59 min:sec, then 0:10 to 9:59 hr:min), 0:00 until started and after reset.
- > Graphic EDT with Elapsed Dive Time (up to 9:59 hr:min).
- > Graphic TMT 1 (2, 3, 4), one in use.
- > Pressure with PSI (or BAR) icon, if the Receiver and Transmitter are active, flashing when Link is lost; or graphic SPG when no Transmitter is in use (SPG = Submersible Pressure Gauge).
- > Gas Time Remaining (min) with icon, up to 99 (remains at 99 when greater), blank if SPG.
- > VARI (AR) - while ascending.
- > Low Battery icon - yellow (if voltage is at the warning level), or red flashing (if voltage is at the alarm level).

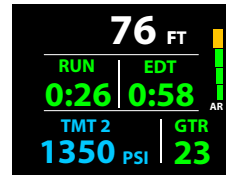

Fig. 67 - GAUG DIVE MAIN

- A (2 sec) - to access Adjust Brightness.
- A (< 2 sec) - to access ALT.
- M (2 sec) - to access the TMT Switch Menu*.
- S (< 2 sec) - to start/stop Run Timer. *This operation is blocked when the screen is dimmed due to Auto Dim and when pressed to acknowledge Alarms when they strike.*
- S (< 2 sec) - to restore screen Brightness from the Auto Dim level to the % level you last adjusted it to.
- S (< 2 sec) - to acknowledge alarms; this will also restore screen Brightness if it was dimmed by Auto Dim.
- S (2 sec) - to access Compass*.

**These items can only be accessed while viewing the Main.*

ADJUST BRIGHTNESS, information includes (Fig. 68):

> xx % (last value saved). Up to 60% max when Low Battery Warning or Alarm.

- S (2 sec) - to step back to the Main without changing the value.
- A (< 2 sec) - to step upward through values of 10% to 100% one at a time in increments of 10%.
- M (< 2 sec) - to step down through values one at a time.
- S (< 2 sec) - to save the % setting and revert to the Main.
- Revert to Main in 10 sec, if no button is pressed.



Fig. 68 - BRIGHTNESS

GAUG DIVE ALT, information includes (Fig. 69):

- > MAX D = xxx FT (or xx.x M).
- > TIME = hr:min with AM (or PM) if 12 Hour Format.
- > TEMP = xx F (or C).

- A (< 2 sec) - to access revert to Main.
- M (< 2 sec) - to step back to Main.
- Revert to Main in 10 sec, if no button is pressed.



Fig. 69 - GAUG DIVE ALT

GAUG DELAYED VIOLATION 3 (DV3)

Upon descent deeper than the 330 FT (100 M)*, the Audible will sound for 10 seconds.

**Beyond this depth, the VTX cannot accurately perform calculations and display data.*

Upon ascending above 330 FT (100 M), Current Depth will be restored, however, Max Depth will display 3 dashes for the remainder of that dive. Also, the Log for that dive will display 3 dashes as the Max Depth.

DV3 MAIN, information includes (Fig. 71) -

- > Current Depth as dashes (- - -) with FT (or M) icon.
- > Graphics GO UP TOO DEEP with Up Arrows (red), flashing.
- > Graphic TMT 1 (or 2, 3, 4), one in use.
- > Pressure with PSI (or BAR) icon, if the Receiver and Transmitter are active, flashing when Link is lost; or graphic SPG.
- > Gas Time Remaining (min) with icon, blank if SPG.
- > VARI (AR) - while ascending.
- > Low Battery icon - yellow (if voltage is at the warning level), or red flashing (if voltage is at the alarm level).

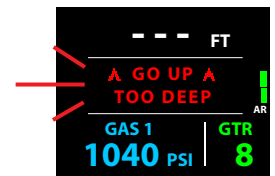

Fig. 71 - GAUG DV3 MAIN

- A (2 sec) - to access Adjust Brightness.
- A (< 2 sec) - to access ALT.
- M (2 sec) - to access the TMT Switch Menu*.
- S (< 2 sec) - to restore screen Brightness from the Auto Dim level to the % level you last adjusted it to.
- S (< 2 sec) - to acknowledge alarms; this will also restore screen Brightness if it was dimmed by Auto Dim.
- S (2 sec) - to access Compass*.

**These items can only be accessed while viewing the Main.*

FREE DIVE OP MODE

FREE SURFACE MODE

FREE dives, which are allowed prior to NORM or GAUG dives as well as after NORM dives, calculate Ni-O2 based upon the Algorithm selected and a fixed default FO2 of Air. FO2 settings for NORM dives do not affect calculations for FREE Dives.

FREE mode displays NDC Time (on a dive ALT screen) and the TLBG (TL) on surface and dive Main screens, and includes a TLBG Alarm that activates when it enters the yellow Caution zone (9 segments).

In the event of entry into Deco during operation in FREE mode, operation reverts to VGM for 24 hours.

FREE dive alarms are set, controlled, and operate separately from NORM and GAUG Alarms.

The SURF Main screen remains on display for 10 minutes during which time the unit will enter Dive Mode upon descent to 5 FT (1.5 M) for 5 seconds.

The unit enters post dive Surface Mode upon ascent to 2 FT (0.6 M) for 1 second and displays the Surface Main with the SURF icon flashing. Access to Surface ALT screens is allowed during the first 10 minute with access to other surface modes/screens blocked until 10 minutes elapse. *Exception is for Violations.*

When the 10 minute post dive Surface Interval time has elapsed, access to other Surface modes/screens is allowed.

FREE SURF MAIN, information includes (Fig. 72):

- > Surface Interval Time (min:sec up to 59:59, then hr:min, colon flashing), with SURF icon (flashing during first minute after surfacing from dives).
- > Graphic FREE.
- > Graphic CDT with Countdown Time (up to 9:59 min:sec), if set ON.
- > Graphic DIVE with number of that dive (up to 99), 0 if no dive yet.
- > TLBG, if any after a NORM or FREE dive.
- > Low Battery icon - yellow (if voltage is at the warning level), or red flashing (if voltage is at the alarm level).

- A (2 sec) - to access the Adjust Brightness screen.
- A (< 2 sec) - to access FREE SURF ALT 1.
- M (2 sec) - to revert to the Home Menu.
- M (< 2 sec) - to access the FREE Menu.
- S (2 sec) - to access the Compass OP Main.

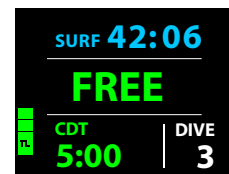

Fig. 72 - FREE SURF MAIN (SURF & CDT are min:sec)

ADJUST BRIGHTNESS, information includes (Fig. 73):

- > xx % (last value saved). *Up to 60% max when Low Battery Warning or Alarm.*

- S (2 sec) - to step back to the Main without changing the value.
- A (< 2 sec) - to step upward through values of 10% to 100% one at a time in increments of 10%.
- M (< 2 sec) - to step down through values one at a time.
- S (< 2 sec) - to save the % setting and revert to the Main.
- Revert to Main in 10 sec, if no button is pressed.

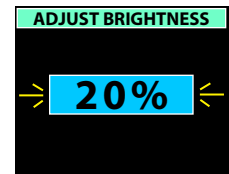

Fig. 73 - BRIGHTNESS

FREE SURF ALT 1, information includes (Fig. 74):

- > LAST DIVE (screen title).
- > xxx FT (or xx.x M) with graphic MAX DEPTH.
- > Elapsed Dive Time (up to 9:59 min:sec) with graphic DIVE TIME.

- A (< 2 sec) - to access SURF ALT 2.
- M (< 2 sec) - to step back to the SURF MAIN.
- 10 sec with no button action, revert to the SURF MAIN.

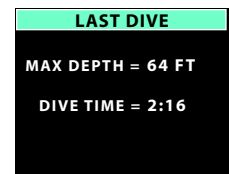

Fig. 74 - FREE SURF ALT 1 (Dive Time is min:sec)

FREE SURF ALT 2, information includes (Fig. 75):

- > DATE = m.d.y (or d.m.y).
- > TIME = hr:min with AM (or PM) if 12 Hour Format.
- > TEMP = xx F (or C).
- > ELEV = SEA (or EL2 to EL7).
- > FLY = hr:min*
- > DESAT = hr:min**

- A (< 2 sec) - to revert to SURF MAIN.
- M (< 2 sec) - to step back to SURF ALT 1.
- 10 sec with no button action, revert to SURF MAIN.



Fig. 75 - FREE SURF ALT 2

*The Time to Fly counter will begin counting down from 23:50 to 0:00 (hr:min) 10 minutes after surfacing from any dive.
 **The Time to Desaturate counter provides calculated time for Tissue Desaturation at sea level taking into consideration the Conservation Factor setting. It will begin counting down 10 minutes after surfacing from a NORM or FREE dive, counting down from a maximum of 23:50 to 0:00 (hr:min).

FREE MENU, information includes (Fig. 76):

- > CDT SETUP - to access a screen to set a Countdown Time, then select On/Off.
- > SET MENU - to access a menu for setting dive related functions.
- A (< 2 sec) - to toggle between Menu selections (the active item highlighted).
- S (< 2 sec) - to access the selection that is highlighted.
- M or S (2 sec) - to step back from the Menu to the FREE SURF MAIN.
- No button action (for 2 min) - will exit the Menu system and revert to the FREE SURF MAIN.



Fig. 76 - FREE SURF MENU

CDT (COUNTDOWN TIMER) SETUP, information includes (Fig. 77):

- > Graphics OFF, ON, and SET with the last selection (OFF or ON) saved highlighted & flashing.
- > Graphic TIME = MIN:SEC with remaining countdown time (min:sec up to 9:59, colon flashing), if ON and a countdown is in progress, or 0:00 with colon flashing if ON & no time is remaining. If OFF, the countdown time previously set is displayed with the colon solid.
- A (< 2 sec) - to step forward (down screen) through and highlight selections.
- M (< 2 sec) - to step back (up screen) through selections.
- S (2 sec) - to revert to FREE Menu.
- S (< 2 sec) - to save the highlighted selection and ->
 - >> If OFF or ON is saved, operation reverts to the FREE Menu. *ON will enable the Timer allowing it to be started/stooped while viewing the FREE Surface Main, ON does not start the countdown.*
 - >> If SET is saved, the graphic MIN and minute digits will be highlighted & flash.
- A (< 2 sec) - to increase Minute Set Point from 0: to 9: in increments of 1: (min) one at a time.
- M (< 2 sec) - to decrease Set Point one at a time.
- S (< 2 sec) - to save the Minute setting and flash the Seconds digits and graphic SEC.
- A (hold) - to increase Seconds Set Point at a rate of 8 per second from :00 to :59 in increments of :01 (sec).
- A (< 2 sec) - to increase the Set Point one at a time.
- M (< 2 sec) - to decrease the Set Point one at a time.
- S (< 2 sec) - to save the full CDT min:sec setting and highlight & flash SET allowing OFF or ON to be selected, saved.



Fig. 77 - FREE CDT SETUP

SET MENU, information includes (Fig. 78):

Selections with their last set points saved include:

- > WATER = with FRESH or SEA.
- > UNITS = with IMPERIAL or METRIC.
- > RTI AL = with OFF or ON. *RTI is Repeating Time Interval alarm. When ON, the alarm activates every 30 seconds during dives.*
- > DA 1 = with OFF, or 30 to 330 FT (or 10 to 100 M), increments of 10 FT (1 M). *DA is Depth Alarm.*
- > DA 2** = with OFF, or 40* to 330 FT (or 11 to 100 M), increments of 10 FT (1 M).
- > DA 3** = with OFF, or 50* to 330 FT (or 12 to 100 M), increments of 10 FT (1 M).



Fig. 78 - FREE SET MENU

*The set point for DA 2 (DA 3) begins one increment greater than the set point saved for DA 1 (DA 2).

**If DA 1 (DA 2) is set OFF, the message DA1 (DA2) MUST BE SET FIRST will be displayed for 10 seconds (Fig. 79) when an attempt is made to set DA 2 (DA 3) for a numeric value when DA 1 (DA 2) is set OFF.

- A (< 2 sec) - to step forward (down screen) through and highlight Menu selections.
- M (< 2 sec) - to step back (up screen) through Menu selections.
- S (< 2 sec), when a selection is highlighted - to highlight & flash that item's set point.
- A (< 2 sec) - to toggle or increase the set point.
- A (hold) - to increase the set point at a rate of 8 per second.
- M (< 2 sec) - to toggle or decrease the set point.
- S (< 2 sec) - to save the setting and highlight the Menu selection.



Fig. 79 - SET DA MESSAGE (appears for 10 sec)

FREE DIVE MAIN, information includes (Fig. 80) -

Either Elapsed Dive Time (EDT) or the Countdown Timer (CDT) can displayed on the Main screen with the other on the Alternate.

Due to short dive times, the Auto Dim feature that automatically dims the screen to a lower level of brightness is not active during FREE dives. Brightness will remain at the % you adjust it to until you change it.

- > Current Depth with FT (or M) icon.
- > Graphic CDT with Countdown Time (from min:sec set to 0:00).
- > Graphic EDT with Elapsed Dive Time (up to 9:59 min:sec).
- > Temperature with F (or C) icon.
- > TLBG (TL), if any from FREE or previous NORM dives.
- > Low Battery icon - yellow (if voltage is at the warning level), or red flashing (if voltage is at the alarm level).

- A (2 sec) - to access Adjust Brightness.
- A (< 2 sec) - to access ALT.
- S (< 2 sec) - to start/stop CDT.
- S (2 sec) - to access Compass*.

*These items can only be accessed while viewing the Main.

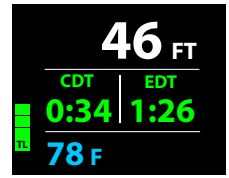

Fig. 80 - FREE DIVE MAIN

ADJUST BRIGHTNESS, information includes (Fig. 81):

> xx % (last value saved). Up to 60% max when Low Battery Warning or Alarm.

- S (2 sec) - to step back to the Main without changing the value.
- A (< 2 sec) - to step upward through values of 10% to 100% one at a time in increments of 10%.
- M (< 2 sec) - to step down through values one at a time.
- S (< 2 sec) - to save the % setting and revert to the Main.
- Revert to Main in 10 sec, if no button is pressed.

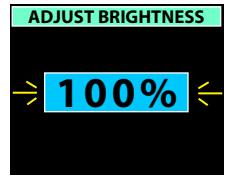

Fig. 81 - BRIGHTNESS

FREE DIVE ALT, information includes (Fig. 82) -

- > MAX D = xxx FT (or xx.x M).
- > TIME = hr:min with AM (or PM) if 12 Hour Format.
- > NDC = hr:min (up to 9:59).

- A or M (< 2 sec) - to step back to FREE Dive Main.
- Revert to Main in 10 sec, if no button is pressed.

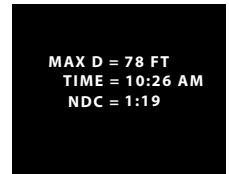

Fig. 82 - FREE DIVE ALT

FREE DIVE ALARMS

FREE mode alarms, which are separate from NORM (or GAUG) alarms, sound 1 or 3 times as (3) short beeps then clear. They cannot be acknowledged or silenced.

FREE CDT Alarm

When a set Countdown Time reaches 0:00, the Audible Alarm will sound during which time the graphic CDT with 0:00 (yellow) will flash on the Dive Main screen* (Fig. 83A), then remain as 0:00 solid. *If EDT was selected and displayed on the Main, it will be replaced by CDT during the audible then EDT will be restored when the audible is silenced.

FREE RTI (EDT) Alarm

When set ON, the RTI (Repeating Time Interval) alarm activates every 30 seconds of EDT (Elapsed Dive Dive) during a dive. The Audible will sound during which time the graphic EDT with Time digits (yellow) will flash on the Dive Main screen* (Fig. 83B), then the screen will return to normal. *If CDT was selected and displayed on the Main, it will be replaced by EDT during the audible then CDT will be restored when the audible is silenced.

FREE Depth Alarms

When set ON, the Depth alarms (1, 2, 3) activate at their set Depths. The Audible will sound during which time the graphic D1 (D2, D3) and Depth digits (yellow) will flash on the Dive Main screen (Fig. 83C), then return to normal.

High Nitrogen Alarms

When nitrogen increases to the caution level (9 segments), the Audible will sound during which time the TLBG segments (green & yellow) will flash on the Dive Main screen (Fig. 83D), then become solid.

In the event that nitrogen continues to increase and reaches the Deco level; the Audible will sound again during which all TLBG segments and the graphics GO UP VIOLATION with Up Arrows will flash on the Dive Main screen until on the surface (Fig. 83E). The TLBG will be removed after the audible is silenced.

Upon surfacing, the graphic VIOL (red) will flash for 1 minute, then alternate with FREE for 24 hours with VGM (Violation Gauge Mode) activated to prevent further dives.

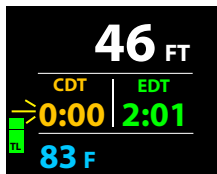

Fig. 83A - CDT ALARM

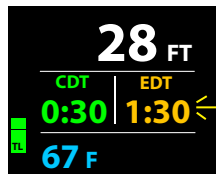

Fig. 83B - EDT ALARM

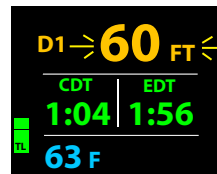

Fig. 83C - DEPTH ALARM

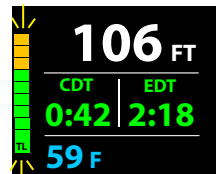

Fig. 83D - TLBG AL

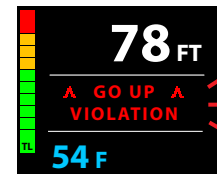

Fig. 83E - VIOLATION (entry into Deco)

ADDITIONAL INFORMATION PERTAINING TO FREE DIVE MODE

Although breathing apparatus is not utilized for FREE Dive activities, nitrogen tissue loading remains a factor. Nitrogen loading is calculated based upon a fixed FO₂ of AIR.

Since a user has the option of alternating between NORM (SCUBA) and FREE Dive activities within a 24 hour period, nitrogen calculations and the displayed value of No Deco Dive Time Remaining (NDC Time) are carried over from one operating mode to the other, which permits the user to maintain awareness of nitrogen absorption and offgasing status.

The mathematical models currently used in the VTX are based on no decompression/decompression multilevel repetitive dive schedules.

These algorithms do not take into account the physiological changes associated with the high pressures that competitive type Free diving can expose a diver to.

 **WARNINGS**

Ensure that you know which Operating Mode is selected (NORM, GAUG, or FREE) prior to commencing any dive.

Conducting Free dives within a 24 hour period after conducting SCUBA dives, combined with the effects of multiple rapid Free Dive ascents, increases your risk of decompression sickness. Such activities may result in accelerated entry into decompression which could cause serious injury or death.

Combining competitive type Free dive activities that involve multiple descents/ascents with activities utilizing SCUBA during the same 24 hour period is not recommended. Presently, there is no data relating to such activities.

It is highly recommended that anyone planning to become involved in competitive type Free dive activities obtain proper instruction and training from a recognized Free Diving trainer. It is imperative that the physiological affects be understood and the diver is physically prepared.

COMPASS MODE

COMPONENTS

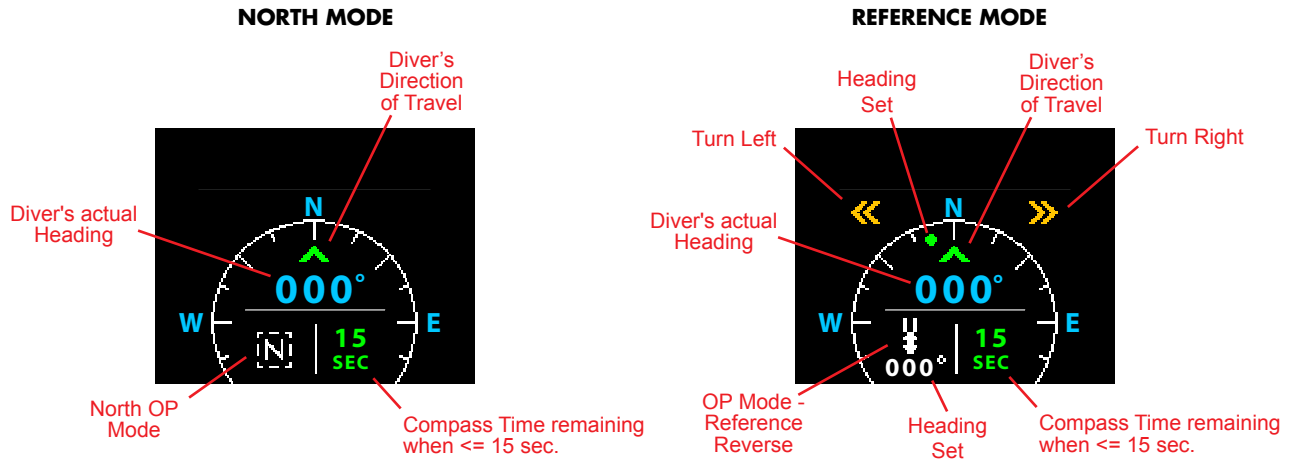

COMPASS MODE SURFACE

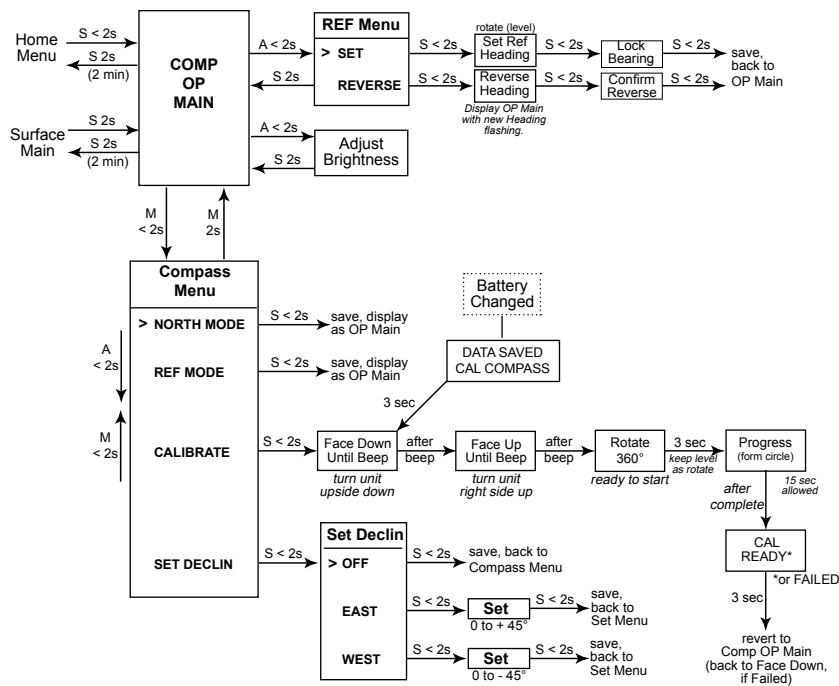

⚠ WARNING: You must become thoroughly familiar with setup and operation of the VTX Digital Compass before using it as your primary device for navigation. Failure to do so could result in serious errors relating to activities involving navigation.

- > Practice on land before use in water.
- > Practice on the surface before use underwater.

OVERVIEW

- > S (2 sec) - to access Compass OP (operating) Main from Surface or Dive Main.
- > S (2 sec), or no button action (2 min*) - to revert to Surface or Dive Main.

*During the final 15 seconds, the remaining On time is displayed. If a button is pressed during that time, the 2 minute On time will reset allowing operation to remain in Compass Mode.

- > Compass OP (operating) Mode selected (North or Reference) - remains until changed.
- > Reference OP Mode - can set a course, then also select a Reverse course while on the surface and during dives.
- > Numeric values are displayed as 3 digits (000 to 360°), have a resolution of 001°, and an accuracy of +/- 005°.
- > Operation will be normal and display of values will be within specified tolerances up to 90° tilt at which time the Heading (diver's direction) digits are removed until the tilt angle is corrected.

Upon accessing the Compass, the OP (operating) Main of the last mode selected will be displayed >> North, Reference, or Reverse Reference.

While on the surface, press M (< 2 sec) to access the Compass Menu to change the OP Mode, Calibrate, or set Declination.

COMPASS MENU, selections include (Fig. 84) -

- > NORTH MODE
- > REFERENCE MODE
- > CALIBRATE
- > SET DECLINATION

- A (< 2 sec) - to step forward (down) through selections.
- M (< 2 sec) - to step back (up) through selections
- S (< 2 sec) - to select the item highlighted.

If NORTH or REFERENCE MODE is selected, that mode will be saved and its Operating Main will be displayed.

- M (2 sec), any time - to revert to Compass OP Main.
- No button action (2 min) - to revert to Surface or Dive Main.

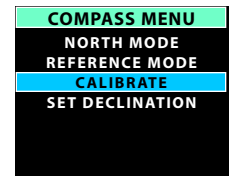

Fig. 84 - COMPASS MENU

NORTH OP MAIN, information includes (Fig. 85A) -

- > Current Depth with FT (or M) icon; or Surface Interval time (hr:min) with SURF icon when on the surface.
- > Static Arrow (green, at 12 o'clock), actual direction of travel.
- > Current dynamic compass (diver) heading (graphic (N, E, SE, etc.).
- > Current (actual) numeric heading value with degrees ° icon. *Removed when tilt exceeds 90°.*
- > North Mode icon (letter N in box).
- > On time remaining with SEC icon, counting down from 15 to 0 (seconds), blank when > 15 seconds remain.
- > VARI (AR), while ascending.
- > Low Battery icon - yellow (if voltage is at the warning level), or red flashing (if voltage is at the alarm level).

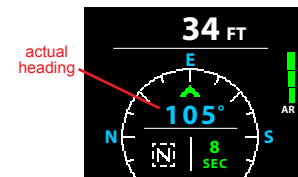

Fig. 85A - NORTH MODE

- A (2 sec) - to access Adjust Brightness. *As previously described.*
- S (2 sec), or no button action during 2 min - to revert to Surface or Dive Main.
- S (< 2 sec) - to restore screen Brightness from the Auto Dim level to the % level you last adjusted it to.
- S (< 2 sec) - to acknowledge alarms; this will also restore screen Brightness if it was dimmed by Auto Dim.
- M (< 2 sec) - to access Compass Menu, surface only.
- M (< 2 sec), while in NORM Dive Mode only - to apply a snapshot Earmark to the PCI data recorded at that time. *The graphics EARMARK APPLIED will be displayed in place of the Compass for 3 seconds (Fig. 85B).*

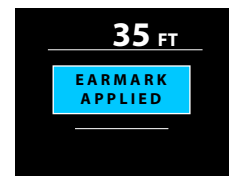

Fig. 85B - DIVE MODE (during 3 sec message)

REFERENCE OP MAIN, information includes (Fig. 86) -

- > Current Depth with FT (or M) icon; or Surface Interval time (hr:min) with SURF icon when on the surface.
- > Turn Arrow (yellow), when actual heading deviates => 10° from the reference course set.
- > Static Arrow (green, at 12 o'clock), actual direction of travel.
- > Current dynamic compass (diver) heading (graphic (N, E, SE, etc.).
- > Current (actual) numeric heading value with degrees ° icon. *Removed when tilt exceeds 90°.*
- > Reference Mode icon (2 bars with arrow) with numeric course set below it, and green dot showing the course set.
- > On time remaining with SEC icon, counting down from 15 to 0 (seconds), blank when > 15 seconds remain.
- > VARI (AR), while ascending.
- > Low Battery icon - yellow (if voltage is at the warning level), or red flashing (if voltage is at the alarm level).

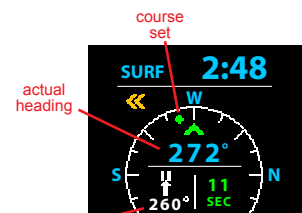

Fig. 86 - REF MODE

- A (2 sec) - to access Adjust Brightness. *As previously described.*
- A (< 2 sec) - to access the Reference Menu
- S (2 sec), or no button action during 2 min - to revert to Surface or Dive Main.
- S (< 2 sec) - to restore screen Brightness from the Auto Dim level to the % level you last adjusted it to.
- S (< 2 sec) - to acknowledge alarms; this will also restore screen Brightness if it was dimmed by Auto Dim.
- M (< 2 sec) - to access Compass Menu, surface only.
- M (< 2 sec), while in NORM Dive Mode only - to apply a snapshot Earmark to the PCI data recorded at that time. *The graphics EARMARK APPLIED will be displayed in place of the Compass for 3 seconds (similar to Fig. 85B).*

REFERENCE MENU, information includes (Fig. 87A) -

- > Current Depth with FT (or M) icon, blank on surface.
 - > SET HEADING.
 - > REVERSE HEADING.
 - > Reference Mode icon (2 bars with arrow) with numeric heading set below it.
 - > On time remaining, counting down, if 15 to 0 (sec).
- A or M (< 2 sec) - to toggle between SET and REVERSE.
 - S (< 2 sec) - to save the selection highlighted, and -
 - > If SET HEADING, display REF OP Main with the Heading previously set flashing allowing it to be set.
 - > If REVERSE HEADING, select it as the OP Mode with new Heading (180° opposite of the Reference Heading set).

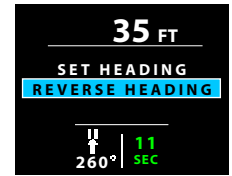

Fig. 87A - REFERENCE MENU

Set Reference Heading, information includes (Fig. 87B) -

- > Current Depth with FT (or M) icon, blank on surface.
- > Static Arrow (green, at 12 o'clock), actual direction of travel.
- > Current dynamic compass (diver) heading (graphic (N, E, SE, etc.).
- > Current (actual) numeric heading value with degrees ° icon. *Removed when tilt exceeds 90°.*
- > Reference Mode icon (2 bars with up arrow) with graphic SET below it flashing.
- > On time remaining with SEC icon, counting down from 15 to 0 (seconds), blank when > 15 seconds remain.
- > VARI (AR), while ascending.

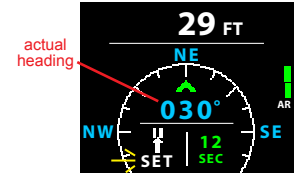

Fig. 87B - SET REFERENCE HEADING (rotate to desired Heading)

- A (2 sec) - to access Adjust Brightness. *As previously described.*
 - S (2 sec), or no button action during 2 min - to revert to Surface or Dive Main.
 - S (< 2 sec) - to flash the Heading value (in the center), with SET solid.
- Rotate (keeping level) in either direction until the new Heading desired is displayed (in the center).
 - S (< 2 sec) - to lock in new Heading, and revert to the Reference OP Main displaying the new Heading value set in place of the graphic SET. *The current (diver's) heading will be displayed in the center.*

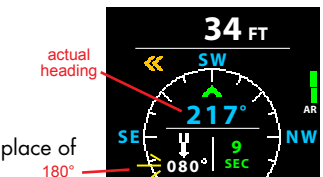

Fig. 87C - REVERSE MODE (rotate to opposite Heading)

Reverse Heading, information includes (Fig. 87C) -

- > Current Depth with FT (or M) icon; or Surface Interval time (hr:min) with SURF icon when on the surface.
- > Static Arrow (green, at 12 o'clock), actual direction of travel.
- > Current dynamic compass (diver) heading (graphic (N, E, SE, etc.).
- > Current (actual) numeric heading value with degrees ° icon. *Removed when tilt exceeds 90°.*
- > Reverse Mode icon (2 bars with down arrow) with new Heading (180 ° opposite) below it flashing.
- > On time remaining with SEC icon, counting down from 15 to 0 (seconds), blank when > 15 seconds remain.
- > VARI (AR), while ascending.
- > Low Battery icon - yellow (if voltage is at the warning level), or red flashing (if voltage is at the alarm level).

- A (2 sec) - to access Adjust Brightness. *As previously described.*
 - S (2 sec), or no button action during 2 min - to revert to Surface or Dive Main.
 - S (< 2 sec) - to confirm the reversal with the new Heading value (below the bar/arrow icon) solid.
- Rotate (keeping level) in either direction until the current heading (in the center) matches the reverse value below.



Fig. 88A - UPON ACCESS (turn unit upside down)

CALIBRATION (surface only)

- > *It may be advantageous to Calibrate the Compass before its first use after purchase, before use in new global regions, or if inaccuracies are experienced. Local magnetic fields can effect display of actual location when reading a digital compass.*
- > *Calibration will be required when the battery is changed.*

Upon selecting Calibration on the Compass Menu (by S < 2 sec), a screen appears displaying the graphics CALIBRATE with TURN FACE DOWN (Fig. 88A)*.

**This screen will also be accessed after the Battery is changed and Data is either saved or cleared.*

To initiate Calibration -

- > Turn the unit over (face down) until it beeps, then turn it over (face up) until it beeps (Fig. 88B), after which a screen appears displaying the graphics CALIBRATE with ROTATE 360° KEEP LEVEL (Fig. 88C).
- > While keeping it in a flat level position, slowly and steadily rotate* it 360° (keeping it level is critical for accuracy), progress will be indicated by a circle forming on the display (Fig. 88D).

**Rotation should take about 15 seconds. If not fully rotated in 15 seconds, operation will revert to the Compass Menu.*

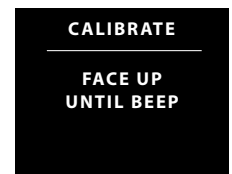

Fig. 88B - AFTER BEEP (turn unit right side up)

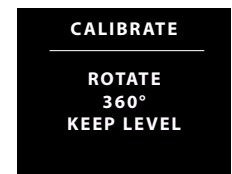

Fig. 88C - TO START



Fig. 88D - PROGRESS (circle forms while rotating)

Calibration complete -

- > Once fully formed, the circle will be replaced with the graphics READY PASSED CALIBRATION (Fig. 88E) or FAILED CALIBRATE AGAIN (Fig. 88F), flashing for 3 seconds, then -
 - > If READY, operation reverts to the Compass OP Main.
 - > If FAILED, operation reverts to the TURN FACE DOWN screen for repeat of the procedure.
 - > If Calibration fails 3 times, operation reverts to the Surface Main screen.

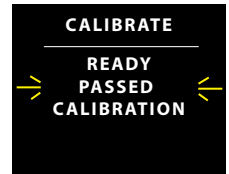

Fig. 88E - PASSED (reverts to Surface Main)

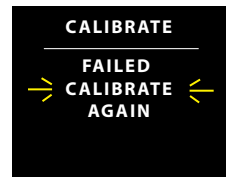

Fig. 88F - FAILED (reverts to Fig. 88A)

DECLINATION

Magnetic Declination is taken from numbers provided on maps or charts that apply to a specific location. The numbers represent the easterly or westerly angular difference (Declination) in degrees between magnetic North and true (geometric or polar) North.

A Compass will point to magnetic North unless its Declination is set to adjust its reference to true North prior to conducting navigation activities.

Declination Menu, information includes (Fig. 89A) -

- > OFF.
 - > EAST with 00°.
 - > WEST with 00°.
- A (< 2 sec) - to step forward (down) through selections.
 - M (< 2 sec) - to step back (up) through selections.
 - S (2 sec) - to step back to the Compass Menu with Set Declination highlighted.
 - S (< 2 sec) - to select the item highlighted.
- > If OFF is selected, Declination is set for 00° and operation reverts to the Compass Menu with Set Declination highlighted.
- > If EAST (or WEST) is selected, the numeric value with ° icon will be highlighted & flash (Fig. 89B).
- A (< 2 sec) - to step up through the set points one at a time from 00 to +/- 45° in increments of 1°.
 - A (hold) - to increase the setting at a scroll rate of 4 per second.
 - M (< 2 sec) - to step down through the set points one at a time.
 - S (< 2 sec) - to save the setting with the EAST (or WEST) highlighted.
 - S (2 sec) - to revert to the Compass Menu with Set Declination highlighted.

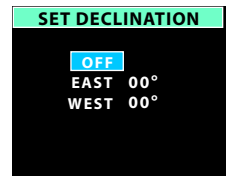

Fig. 89A - DECLINATION MENU

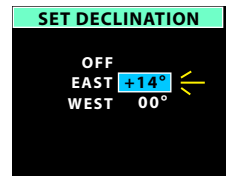

Fig. 89B - SET DECLIN

ALARMS (while in Compass Mode)

When most Alarms strike, operation in Compass Mode will be terminated and the Dive Main will be displayed indicating the alarm condition. Compass Mode can then be reentered by pressing S (2 sec).

During several types of alarms, indication will be given while remaining in Compass Mode without interruption. They are -

Ascent Alarm (Fig. 90A) -

- > VARI (AR) - all segments (their usual colors) flash until slowed.

Depth Alarm (Fig. 90B) -

- > Depth digits (red) flash during the audible, then return to their normal color (white) solid.

Loss of Link (Fig. 90C) -

- > Graphic LOST LINK (yellow) flashes in place of Depth during audible, then Depth is restored.

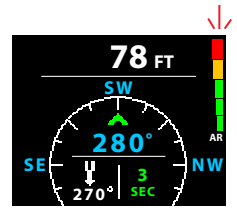

Fig. 90A - ASCENT ALARM

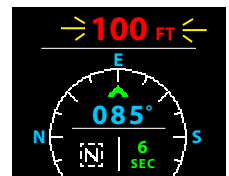

Fig. 90B - DEPTH ALARM

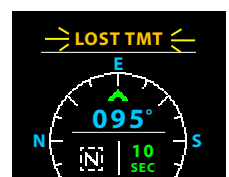

Fig. 90C - LOSS OF LINK

NORM/GAUG

DIVE MODE

ALARMS

DEPTH ALARM (Fig. A1)

Audible >> sounds until acknowledged, time out (10 sec), or ascent is made to a depth less than the value set.
 Depth digits >> flash (red) during Audible, then solid (white).

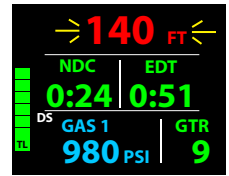

Fig. A1 - DEPTH ALARM

ELAPSED DIVE TIME (EDT) ALARM (Fig. A2)

Audible >> sounds until acknowledged or time out (10 sec).
 EDT digits >> flash (red) in place of normal data during the Audible, then normal data is restored.

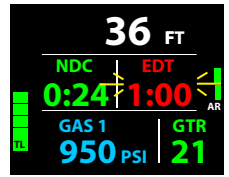

Fig. A2 - EDT ALARM

NORM TISSUE LOADING BAR GRAPH (TL) ALARM (Fig. A3)

Audible >> sounds until acknowledged or time out (10 sec), or it decreases to 1 segment less than the value set.
 TL (bar graph) >> loaded segments (their usual green, yellow colors) flash during the Audible, then return to solid.

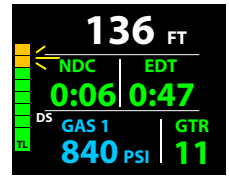

Fig. A3 - TL ALARM

TURN PRESSURE ALARM (TMT 1 only) (Fig. A4)

Audible >> sounds until acknowledged or time out (10 sec).
 Pressure digits >> flash (yellow) until the Audible is silenced, then return to solid (normal color, light blue).
 Graphic >> TURN PRESS flashes (yellow) in place of normal data during the Audible, then normal data is restored.

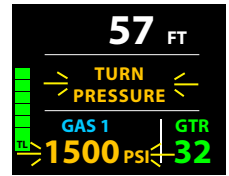

Fig. A4 - TURN ALARM

END PRESSURE ALARM (TMT in use) (Fig. A5)

Audible >> sounds until acknowledged or time out (10 sec).
 Pressure digits >> flash (red) until the Audible is silenced, then return to solid (normal color, light blue).
 Graphic >> END PRESS flashes (red) in place of normal data during the Audible, then normal data is restored.

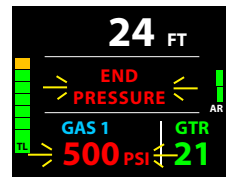

Fig. A5 - END ALARM

NORM DIVE TIME REMAINING (DTR) ALARM (Fig. A6)

Audible >> sounds until acknowledged or time out (10 sec).
 DTR digits & icon >> flash (red) until the Audible is silenced, then return to solid (normal color, green).

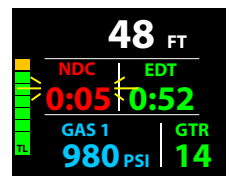

Fig. A6 - DTR ALARM

ASCENT ALARM (Fig. A7)

Audible >> sounds until acknowledged or time out (10 sec) or ascent rate is slowed.
 AR (bar graph) >> all 5 segments (green, yellow, red) flash until Ascent Rate is slowed, then return to solid.

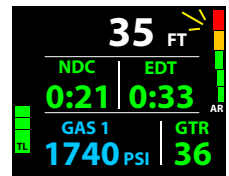

Fig. A7 - ASCENT ALARM

GAS TIME REMAINING (GTR) WARNING (at 5 min) (Fig. A8)

Audible >> sounds until acknowledged or time out (10 sec), or GTR > 5 min.
 GTR digits & icon >> flash (yellow) until the Audible is silenced and GTR > 5 min, then return to solid (normal color, green).

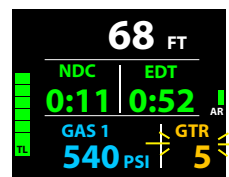

Fig. A8 - GTR WARNING

GAS TIME REMAINING (GTR) ALARM (at 0 min) (Fig. A9)

Audible >> sounds until acknowledged or time out (10 sec), or GTR => 1 min.

GTR digits & icon >> flash (red) until the Audible is silenced, then the digits flash (yellow) until GTR > 5 min, then return to solid (normal color, green).

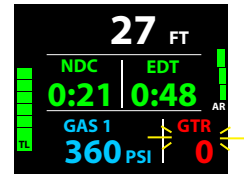

Fig. A9 - GTR WARNING

LOST LINK WITH TRANSMITTER (TMT in use) (Fig. A10)

Activate >> TMT signal interrupted for 15 sec.

Audible >> sounds until acknowledged or time out (10 sec).

Pressure digits & PSI (or BAR) icon >> flash (normal color) until the Link is regained, or time out of 8.5 minutes after surfacing*. At 1 minute, the last Pressure reading will be ---- PSI (-- BAR).

**Pressure < 50 PSI (4 BAR) will be displayed as ---- PSI (-- BAR) for 2 minutes, then the TMT will shut down.*

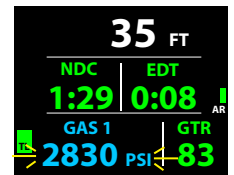

Fig. A10 - LOST LINK

LOW BATTERY WARNING & ALARM - refer to page 8.

DECO & VIOLATIONS - refer to pages 28 to 30.

HIGH PO2 WARNINGS & ALARMS - refer to page 30.

HIGH O2 WARNINGS & ALARMS - refer to page 31.

FREE DIVE WARNINGS & ALARMS - refer to page 41.

COMPASS MODE WARNINGS & ALARMS - refer to page 47.

REFERENCE



CAUTION: When the procedure provided in this section is used to change the VTX Battery, you must be sure that the case o-ring is not pinched and that the VTX is water tight before conducting diving activities. Pre dive pressure testing by an Authorized Oceanic facility is highly recommended.

UPLOADING/DOWNLOADING

As previously described (page 13), the VTX can be paired with a PC, Mac, or mobile device utilizing the Bluetooth function together with a dongle* (Fig. 91) that plugs into the PC/Mac USB port.

**The dongle can be obtained as an optional accessory from an Authorized Oceanic Dealer.*

It can also be connected with a PC or Mac using a USB cable and adapter clip provided.

USB Connection

The VTX is configured with a 4 pad interface connection port located on the back of the case (Fig. 92).

To connect the VTX to a PC or Mac USB port, the USB interface cable provided is connected into the adapter clip provided (Fig. 93A) that is clamped onto the VTX.

When clamping the clip onto the VTX, ensure that the 4 pins on the clip are properly fitted over the 4 pads on the VTX (Fig. 93B).



Fig. 91 - BLUETOOTH DONGLE



Fig. 92 - INTERFACE PORT



Fig. 93A - USB CABLE ADAPTER CLIP



Fig. 93B - ADAPTER CLIP INSTALLED

Bluetooth connection will be blocked when there is USB connection. If a USB connection cable is plugged in while there is Bluetooth connection, the Bluetooth connection will be disabled.

If a download, upload, or firmware update operation is in progress using Bluetooth, the operation will be allowed then the Bluetooth connection will be disabled upon completion when the USB connecting screen is to be displayed (Fig. 94A) until the connection is accepted then a 120 second countdown is to be displayed (Fig. 94B) until the connection is made indicated by the signal icons changing from white to green with the graphic (Fig. 94C).

While downloading data, uploading settings, and updating firmware, corresponding screens are displayed indicating action in progress (Fig. 94D, 94E, 94F).



Fig. 94A - CONNECTING



Fig. 94B - COUNTDOWN

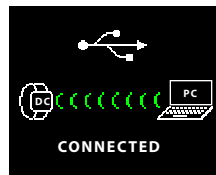

Fig. 94C - CONNECTION MADE



Fig. 94D - IN PROGRESS



Fig. 94E - IN PROGRESS



Fig. 94F - UPDATE COMPLETED

PC requirements:

- IBM®, or compatible, PC with Intel® Pentium 4 or better microprocessor
- Microsoft® Windows® XP, Vista, 7, or 8
- Super VGA card or compatible video graphics adaptor (256 color or greater) with a minimum 800 X 600 pixel screen area of display settings
- 128MB of available RAM
- 64MB of available hard drive storage
- Mouse
- CD Rom drive
- Printer

Mac requirements:

- Mac with OSX 10.5 or later
- Super VGA card or compatible video graphics adaptor (256 color or greater) with a minimum 800 X 600 pixel screen area of display settings
- 128MB of available RAM
- 64MB of available hard drive storage
- Mouse
- Printer
- Internet connection to download App from the Apple App Store

For software updates, refer to the Oceanic web site >>>> www.OceanicWorldwide.com

For support, call Oceanic Customer Service toll free at >>>> (866) 732-7877, 8 Am to 5 Pm USA Pacific time.

ALTITUDE SENSING AND ADJUSTMENT

Prior to the first dive of a series of repetitive dives, Altitude (i.e., ambient pressure) is measured upon activation then every 15 minutes until a dive is made.

- > Measurements are only taken when the unit is dry.
- > Two readings are taken, the second reading 5 seconds after the first. The readings must be within 1 foot (30 cm) of each other to record that ambient pressure as the current Altitude.
- > No adjustments are made during any time that the Wet Contacts are bridged.

When diving in high altitude waters from 3,001 to 14,000 feet (916 to 4,270 meters), the VTX automatically adjusts to these conditions providing corrected Depth, and reduced No Deco and O₂ Times at intervals of 1,000 feet (305 meters).

At an elevation of 3,001 feet (916 meters), Depth calibration automatically changes from feet of seawater to feet of fresh water. This is the first adjustment to the algorithm.

When the Conservative Factor feature is set On, NDLs are calculated based upon the next higher 3,000 foot (915 meter) Altitude. All adjustments for Altitudes greater than 11,000 feet (3,355 meters) are then made to allowable dive times for 14,000 feet (4,270 meters). At Sea Level, calculations are based upon an Altitude of 6,000 feet.

The VTX will not function above 14,000 feet (4,270 meters).

CARE AND CLEANING

Protect your unit from shock, excessive temperatures, exposure to chemicals, and tampering. Protect the lens against scratches with a Instrument Lens Protector. Small scratches will naturally disappear underwater.

- Soak and rinse the VTX in fresh water at the end of each day of diving, and check to ensure that the areas around the low pressure (depth) sensor (Fig. 95a), data port (Fig. 95b), and buttons are free of debris or obstructions. Soak and rinse the regulator with the transmitter attached.
- To dissolve salt crystals, use lukewarm water or a slightly acidic bath (50% white vinegar/50% fresh water). After removal from the bath, place the VTX and the regulator assembly with transmitter under gently running water and towel dry before storing.
- Transport your VTX system cool, dry, and protected.



Fig. 95 - CASE BACK

INSPECTIONS AND SERVICE

Your VTX should be inspected annually by an Authorized Oceanic Dealer who will perform a factory prescribed function check and inspection for damage or wear. To keep the 2 year limited warranty in effect, this inspection must be completed one year after purchase (+/- 30 days).

Oceanic recommends that you continue to have an inspection performed every year to ensure it is working properly. The costs of annual inspections are not covered under the terms of the 2 year limited warranty.

To Obtain Service:

Take your VTX to an Authorized Oceanic Dealer.

To return your VTX to Oceanic:

- Record all data in the viewable Log and/or download the data in memory. All data will be erased during factory service.
- Package it using a protective cushioning material.
- Include a legible note stating the specific reason for return, your name, address, daytime phone number, serial number(s), and a copy of your original sales receipt and Warranty Registration Card.
- Send freight prepaid and insured using a traceable method to the nearest Oceanic Regional Facility, or to Oceanic USA.
- If shipping to Oceanic USA, obtain an RA (Return Authorization) number by contacting Oceanic at 510-562-0500 x761 or 800-435-3483 x 761, or send an e-mail to service@oceanicusa.com.
- Non warranty service must be prepaid. COD is not accepted.
- Additional information is available at the Oceanic web site >>>>

OceanicWorldwide.com

BATTERY REPLACEMENT

The procedures that follow must be closely adhered to to avoid entrance of water into the unit. Damage due to improper Battery replacement (or subsequent leakage of moisture into the unit) is not covered by the VTX's 2 year warranty.

The Battery Compartment should only be opened in a dry and clean environment with extreme care taken to prevent the entrance of moisture or dust.

As an additional precautionary measure to prevent formation of moisture in the Battery Compartment, it is recommended that the Battery be changed in an environment equivalent to the local outdoor temperature and humidity (e.g., do not change the Battery in an air conditioned environment then take it outside during a hot sunny day).

Inspect the Buttons, Lens, and Housing to ensure they are not cracked or damaged. If there is any sign of moisture inside the unit, DO NOT attempt to use it for diving until it receives proper service by the Oceanic factory or an Authorized Regional Facility.

Data Retention (calculations & settings)

When the battery is removed, settings* and calculations for repetitive dives are retained in volatile memory until a new battery is installed.

**Date will have to be set, Time may require adjustment for the time duration that the battery remains out of the unit.*

After the Battery is replaced during a 24 hour period after dives, a screen displaying the graphics DATA SAVED CALIBRATE COMPASS displayed for 3 seconds (Fig. 96) that will then switch to the Compass Calibrate Face Down screen.

- > Calibrate the Compass. Refer to page 45.
- > Verify all Set points prior to diving.

BATTERY REMOVAL

Locate the Battery Cover on the end of the housing:

- Apply a coin to the recessed slot of the Cover and turn it counter clockwise out of the housing (Fig. 97).
- Remove the Battery and discard it according to local regulations governing disposal of Lithium batteries.

INSPECTION

- Closely check all of the sealing surfaces for any signs of damage that might impair proper sealing.
- Inspect the Buttons, Lens, and Housing to ensure they are not cracked or damaged.
- Remove the Battery Cover O-ring and inspect it for any signs of deterioration or deformity. DO NOT use tools to remove the O-ring.
- To ensure proper sealing, O-ring replacement is highly recommended each time the Battery is replaced.
- Closely examine the Battery Cover and Housing for any signs of damage that might prevent proper threading.
- Closely examine the inside of the Battery Compartment for any signs of corrosion indicating entrance of moisture into the unit.

⚠ WARNING: If damage, moisture, or corrosion is found, return your unit to an Authorized Oceanic Dealer, and DO NOT attempt to use it until it has received factory prescribed service.

BATTERY INSTALLATION

- Lightly lubricate the new Battery Cover O-ring with silicone grease and install it onto the Battery Cover. DO NOT roll the O-ring over the Threads, instead stretch it slightly to work it down over the slotted end of the Cover into the groove at the base of the threads (Fig. 98).
- The O-ring must be a genuine Oceanic part that can be purchased from an Authorized Oceanic Dealer.

Use of any other O-ring will void the warranty.

- Insert a new CR2 Lithium 3 Volt Battery (Duracell or equivalent) positive (+) side first into the Battery compartment with the negative end facing out (Fig. 99).
- Ensure that the Battery is properly installed and the Cover O-ring is evenly seated around the Cover.
- Carefully place the Cover (with spring) into the housing and turn clockwise slowly by hand to ensure proper threading.
- Apply a coin and tighten the Cover by turning it clockwise until secure (Fig. 100). The outer surface of the Cover should be flush with the outer surface of the housing.

DATA SAVED

CALIBRATE

COMPASS

Fig. 96 - CALCULATIONS & SETTINGS



Fig. 97 - REMOVING THE BATTERY COVER



Fig. 98 - INSTALLING THE COVER O-RING



Fig. 99 - INSERTING THE BATTERY



Fig. 100 - COVER SECURED

TRANSMITTER BATTERY REPLACEMENT

Battery Removal

Locate the Battery Cover on the end of the housing:

- Apply a coin to the recessed slot of the Cover and turn it counter clockwise out of the housing (Fig. 101).
- Remove the Battery and discard it according to local regulations governing disposal of Lithium batteries.

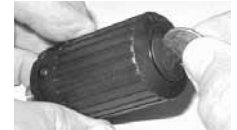

Fig. 101 - COVER REMOVAL

Battery Installation

- Lightly lubricate the new Battery Cover O-ring with silicone grease and install it onto the Battery Cover. DO NOT roll the O-ring over the Threads, instead stretch it slightly to work it down over the slotted end of the Cover into the groove at the base of the threads (Fig. 102).
- The O-ring must be a genuine Oceanic part that can be purchased from an Authorized Oceanic Dealer.



Fig. 102 - INSTALLING COVER O-RING

Use of any other O-ring will void the warranty.

- Insert a new CR2 Lithium 3 Volt Battery (Duracell or equivalent) positive (+) side first into the Battery compartment with the negative end facing out (Fig. 103).
- Ensure that the Battery is properly installed and the Cover O-ring is evenly seated around the Cover.
- Carefully place the Cover (with spring) into the housing and turn clockwise slowly by hand to ensure proper threading.
- Apply a coin and tighten the Cover by turning it clockwise until secure (Fig. 104). The outer surface of the Cover should be flush with the outer surface of the housing.



Fig. 103 - ORIENTATION

TRANSMITTER INSTALLATION ON A REGULATOR

- Remove the existing pressure gauge and high pressure hose, or the high pressure port plug from the port marked HP using the proper size hex key.
- Lightly lubricate the o-ring and threads of the Transmitter fitting with a halocarbon based lubricant such as Christo-Lube MCG111.
- Thread the Transmitter clockwise by hand into the regulator's HP port (Fig. 105) and tighten until secure with an appropriate sized open end wrench.
- Attach the regulator First Stage to a full scuba tank and pressurize by slowly opening the tank valve, listening for any indication of air leaking around the fitting.
- If air leakage is present, DO NOT use, take the complete regulator assembly to an Authorized Oceanic Dealer for inspection and service.



Fig. 104 - TRANSMITTER COVER INSTALLED

TRANSMITTER COMPATIBILITY WITH NITROX

When packaged and shipped from the factory, Oceanic Transmitters are rated for use with compressed Air and/or nitrogen-oxygen (Nitrox) breathing gas mixtures containing up to 99% O₂ by volume and with 100% O₂.



Fig. 105 - TRANSMITTER ON FIRST STAGE

WARNINGS

Decompression diving, or diving deeper than 130 FT (39 M), will greatly increase your risk of decompression sickness.

Decompression diving is inherently hazardous and greatly increases your risk of decompression sickness, even when performed according to the dive computer's calculations.

Using an VTX is no guarantee of avoiding decompression sickness.

The VTX enters Violation Mode when a situation exceeds its capacity to predict an ascent procedure. These dives represent gross excursions into decompression that are beyond the boundaries and spirit of the VTX's design. If you are following these dive profiles, Oceanic advises that you should not use an VTX.

If you exceed certain limits, the VTX will not be able to help you get safely back to the surface. These situations exceed tested limits and can result in loss of some functions for 24 hours after the dive in which a violation occurred.

TECHNICAL DATA

SPECIFICATIONS

CAN BE USED AS

- Dive Computer (Air or Nitrox) with up to 4 Gases up to 100% O₂ and 4 Transmitters.
- Digital Depth Gauge/Timer with up to 4 Transmitters.
- Free Dive (breath hold) activity with Depth Gauge, Countdown Timer.
- Compass.

DIVE COMPUTER PERFORMANCE

- Buhlmann ZHL-16c based Pelagic Z+, or DSAT based, algorithm.
- No Deco limits closely follow PADI RDP.
- Decompression in agreement with Buhlmann ZHL-16c and French MN90.
- No Deco Deep Stops >> Morroni, Bennett.
- Deco Deep Stops (not recommended) >> Blatteau, Gerth, Gutvik.
- Altitude >> Buhlmann, IANTD, RDP (Cross).
- Altitude corrections and O₂ limits based on NOAA tables.

TRANSMITTERS (TMTs)

- Battery and Pressure check
 - >> every 2 seconds when awake
- Startup
 - >> Pressure => 120 PSI (8 BAR)
 - >> Battery => 2.75 volts
- Shutdown
 - >> Pressure < 50 PSI (4 BAR)

TMT Compatibility with Nitrox

- When packaged and shipped from the factory, Oceanic Transmitters are rated for use with compressed gas containing up to 100% O₂ by volume.

OPERATIONAL PERFORMANCE

Function:

- Depth
- Timers

Accuracy:

- ±1% of full scale
- 1 second per day

Activation:

- Manual activation by pressing any button.
- Cannot be manually activated deeper than 4 FT (1.2 M).
- Will not operate at elevations higher than 14,000 feet (4,270 meters).
- Automatic activation of Dive Mode by wet activation contacts upon descent to 5 FT (1.5 M) for 5 seconds.

Unit Shutoff:

- 2 hours after activation, if no dive conducted.
- 24 hours after conducting a dive, if no further dives conducted.

Dive Counter:

- NORM & GAUG modes display Dives #1 to 24, FREE mode displays #1 to 99 (0 if no dive made yet).
- Resets to Dive #1 upon diving after 24 hours with no dives.

Dive Log Mode:

- Stores 24 most recent NORM & GAUG dives in memory for viewing.
- After 24 dives, adds 25th dive in memory and deletes the older dive.

Altitude:

- Operational from sea level to 14,000 feet (4,270 meters) elevation.
- Measures ambient pressure upon activation and every 15 minutes while in Surface modes.
- Does not measure ambient pressure when Wet.
- Compensates for Altitudes above sea level beginning at 3,001 feet (916 meters) elevation and every 1,000 feet (305 meters) higher.

Power Supply:

- VTX Battery (1) 3 vdc, CR2, 800 mAh, Lithium battery (Duracell, Energizer, Panasonic, or Rayovac recommended)
- Use Life 15 operating hours at 100% brightness with Auto Dim set Off
- Transmitter Battery (1) 3 vdc, CR2, .75 Ahr, Lithium battery (Duracell or equivalent)
- Use Life 300 dive hours if (2) 1 hour dives per dive day
- Shelf life Up to 5 years
- Replacement User replaceable (annual recommended)

Power Saver Mode (surface):

- Activates and turns screen off when 2 minutes elapse on surface with no button operations.
- Resume operation from Power Saver Mode by pressing any button.

SPECIFICATIONS (CONTINUED)

Battery Indication:

- Good (> 2.75 v) >> no Battery icon is displayed. *No restrictions surface or dive..*
- Warning (<= 2.75 v) >> Low Battery icon (yellow) solid on Surface and Dive Mains, Battery change recommended. *Brightness level automatically limited to 60% maximum.*
- Alarm (<= 2.50 v) >> Low Battery icon (red) flashing on Surface and Dive Mains. Graphics GO UP LOW BATTERY with Up Arrows flashing on Dive Mains, graphics CHANGE BATTERY (red) flashing on Surface Mains until the unit the shuts off. *Must change the Battery.*

Transmitter Battery Indication:

- Warning (<= 2.75 v) >> graphic BATT LOW (yellow) solid on BATT, TMT STATUS screen, Battery change recommended.
- Alarm (<= 2.50 v) >> graphic TMTx LOW BATTERY (red) alternating with graphic NORM (or GAUG, or FREE) on Surface Main. *Change the Battery.*
- Alarm (<= 2.50 v) >> graphic BATT LOW (red) flashing on BATT, TMT STATUS screen. *Change the Battery.*

Operating Temperature:

- Out of the water >> between 20 °F and 140 °F (-6 and 60 °C).
- In the water >> between 28 °F and 95 °F (-2 and 35 °C).

BAR GRAPHS:

TLBG	<u>segments</u>
• No Deco Normal zone	1 to 6 (green)
• No Deco Caution zone	7 to 9 (yellow)
• Decompression zone	10 (red)

VARI	<u>60 FT (18 M) & Shallower</u>			<u>Deeper than 60 FT (18 M)</u>		
	<u>segments</u>	<u>FPM</u>	<u>MPM</u>	<u>segments</u>	<u>FPM</u>	<u>MPM</u>
	0	0 - 10	0 - 3	0	0 - 20	0 - 6
• Normal zone (green)	1	11 - 15	3.5 - 4.5	1	21 - 30	6.5 - 9
• Normal zone (green)	2	16 - 20	5 - 6	2	31 - 40	9.5 - 12
• Normal zone (green)	3	21 - 25	6.5 - 7.5	3	41 - 50	12.5 - 15
• Caution zone (yellow)	4	26 - 30	8 - 9	4	51 - 60	15.5 - 18
• Too Fast zone (red)	5 (all flash)	> 30	> 9	5 (all flash)	> 60	> 18

NUMERIC DISPLAYS:

	<u>Range:</u>	<u>Resolution:</u>
• Time of Day	0:00 to 23:59 hr:min	1 minute
• PC/Mac Countdown Timer	2:00 to 0:00 min:sec	1 second
• Altitude Level	Sea, EL-2 to EL-7	1 (level)
• Time to Fly	23:50 to 0:00 hr:min	1 minute
• Time to Desaturate	23:50 to 0:00 hr:min	1 minute
• Temperature	0 to 99 F (-18 to 60 C)	1 F (C)
• Depth, Max Depth (display)	0 to 330 FT (100 M)	1 FT (0.1 M)
• Tank Pressure	0 to 5000 PSI (345 BAR)	5 PSI (1 BAR)
• NORM, GAUG Surface Interval	0:00 to 23:59 hr:min	1 minute
• NORM, GAUG Dive Number	0 to 24	1 (dive)
• NORM, GAUG Log Entry Number	0 to 99	1 (dive)
• NORM, GAUG Elapsed Dive Time	0:00 to 9:59 hr:min	1 minute
• NORM Dive Time Remaining	0:00 to 9:59 hr:min	1 minute
• NORM, GAUG Gas Time Remaining	0 to 99 min	1 minute
• FO2 Set Point (Gas 1, 2, 3, 4)	Air, 21 to 100 %	1 %
• PO2 (current value)	0.00 to 5.00 ATA	.01 ATA
• O2 Saturation	0 to 100 %	1 %
• No Deco Deep Stop Time	2:00 to 0:00 min:sec	1 second
• No Deco Safety Stop Time	5:00 to 0:00 min:sec	1 second
• No Deco Safety Stop Run Timer	0:00 to 9:59 min:sec	1 second
• GAUG Dive Run Timer	0:00 to 9:59 min:sec 0:10 to 9:59 hr:min	1 second 1 minute
• Deco Stop Time	0:00 to 9:59 hr:min	1 minute
• Deco Total Ascent Time	0:00 to 9:59 hr:min	1 minute
• Violation Countdown Timer	23:50 to 0:00 hr:min	1 minute

SPECIFICATIONS (CONTINUED)

NUMERIC DISPLAYS:	Range:	Resolution:
• FREE Surface Interval	0:00 to 59:59 min:sec 1:00 to 23:59 hr:min	1 second 1 minute
• FREE Dive Number	0 to 99	1
• FREE Countdown Timer	9:59 to 0:00 min:sec	1 second
• FREE Elapsed Dive Time	0:00 to 9:59 min:sec	1 second
• Compass Heading	001 to 360°	001°
• Compass Op Time Remaining	15 to 1 sec	1 sec



WARNING: If your VTX stops working for any reason while operating as a Dive Computer, it is important that you have anticipated this possibility and are prepared for it. This is an important reason for not pushing the no decompression and oxygen exposure limits, and a critical reason to avoid entering decompression.

If you dive in situations where your trip would be ruined or your safety would be jeopardized by losing the use of your VTX, a backup instrument system is highly recommended.

**DSAT BASED NDLS (HR:MIN)
(IMPERIAL)**

Altitude (feet)	0 to 3000	3001 to 4000	4001 to 5000	5001 to 6000	6001 to 7000	7001 to 8000	8001 to 9000	9001 to 10000	10001 to 11000	11001 to 12000	12001 to 13000	13001 to 14000
Depth (FT)												
30	4:20	3:21	3:07	2:55	2:45	2:36	2:28	2:21	2:15	2:10	2:04	1:58
40	2:17	1:43	1:36	1:30	1:25	1:20	1:16	1:12	1:09	1:06	1:03	1:01
50	1:21	1:03	1:00	0:58	0:55	0:52	0:48	0:45	0:43	0:41	0:39	0:37
60	0:57	0:43	0:40	0:38	0:36	0:34	0:33	0:31	0:30	0:29	0:28	0:27
70	0:40	0:31	0:30	0:28	0:27	0:26	0:24	0:23	0:22	0:20	0:19	0:18
80	0:30	0:24	0:23	0:21	0:20	0:19	0:18	0:17	0:16	0:16	0:14	0:13
90	0:24	0:19	0:18	0:17	0:16	0:15	0:14	0:13	0:12	0:11	0:10	0:10
100	0:19	0:15	0:14	0:13	0:12	0:11	0:10	0:10	0:09	0:09	0:08	0:08
110	0:16	0:12	0:11	0:10	0:09	0:09	0:08	0:08	0:08	0:07	0:07	0:07
120	0:13	0:09	0:09	0:08	0:08	0:08	0:07	0:07	0:07	0:06	0:06	0:06
130	0:11	0:07	0:07	0:07	0:06	0:06	0:06	0:06	0:05	0:05	0:05	0:05
140	0:09	0:07	0:07	0:06	0:06	0:06	0:06	0:05	0:05	0:05	0:05	0:05
150	0:08	0:06	0:06	0:06	0:05	0:05	0:05	0:05	0:05	0:04	0:04	0:04
160	0:07	0:06	0:05	0:05	0:05	0:05	0:05	0:04	0:04	0:04	0:04	0:04
170	0:07	0:05	0:05	0:05	0:04	0:04	0:04	0:04	0:04	0:04	0:04	0:03
180	0:06	0:05	0:05	0:04	0:04	0:04	0:04	0:04	0:04	0:03	0:03	0:03
190	0:05	0:04	0:04	0:04	0:04	0:04	0:04	0:03	0:03	0:03	0:03	0:03

**DSAT BASED NDLS (HR:MIN)
(METRIC)**

Altitude (meters)	0 to 915	916 to 1220	1221 to 1525	1526 to 1830	1831 to 2135	2136 to 2440	2441 to 2745	2746 to 3050	3051 to 3355	3356 to 3660	3661 to 3965	3966 to 4270
Depth (M)												
9	4:43	3:37	3:24	3:10	2:58	2:48	2:39	2:31	2:24	2:18	2:12	2:07
12	2:24	1:52	1:44	1:37	1:30	1:25	1:21	1:17	1:13	1:10	1:07	1:04
15	1:25	1:06	1:03	1:00	0:57	0:55	0:52	0:49	0:46	0:43	0:41	0:39
18	0:59	0:45	0:42	0:40	0:38	0:36	0:34	0:32	0:31	0:30	0:29	0:28
21	0:41	0:33	0:31	0:29	0:28	0:27	0:26	0:24	0:23	0:21	0:20	0:19
24	0:32	0:26	0:24	0:22	0:21	0:20	0:19	0:18	0:17	0:16	0:15	0:14
27	0:25	0:19	0:18	0:17	0:16	0:16	0:14	0:13	0:12	0:12	0:11	0:10
30	0:20	0:16	0:15	0:13	0:12	0:12	0:11	0:10	0:10	0:09	0:09	0:08
33	0:17	0:12	0:11	0:11	0:10	0:09	0:09	0:08	0:08	0:08	0:07	0:07
36	0:14	0:10	0:09	0:09	0:08	0:08	0:07	0:07	0:07	0:06	0:06	0:06
39	0:11	0:08	0:08	0:07	0:07	0:07	0:06	0:06	0:06	0:06	0:05	0:05
42	0:09	0:07	0:07	0:07	0:06	0:06	0:06	0:05	0:05	0:05	0:05	0:05
45	0:08	0:06	0:06	0:06	0:06	0:05	0:05	0:05	0:05	0:05	0:04	0:04
48	0:07	0:06	0:06	0:05	0:05	0:05	0:05	0:04	0:04	0:04	0:04	0:04
51	0:06	0:05	0:05	0:05	0:05	0:04	0:04	0:04	0:04	0:04	0:04	0:04
54	0:06	0:05	0:05	0:04	0:04	0:04	0:04	0:04	0:04	0:03	0:03	0:03
57	0:05	0:04	0:04	0:04	0:04	0:04	0:04	0:03	0:03	0:03	0:03	0:03

ALTITUDE LEVELS

Display:

- SEA = Level 1 (Sea Level)
- L2 = Level 2
- L3 = Level 3
- L4 = Level 4
- L5 = Level 5
- L6 = Level 6
- L7 = Level 7

Range:

- 0 to 3,000 feet (0 to 915 meters)
- 3,001 to 5,000 feet (916 to 1,525 meters)
- 5,001 to 7,000 feet (1,526 to 2,135 meters)
- 7,001 to 9,000 feet (2,136 to 2,745 meters)
- 9,001 to 11,000 feet (2,746 to 3,355 meters)
- 11,001 to 13,000 feet (3,356 to 3,965 meters)
- > 13,000 feet (3,965 meters)

**Z+ BASED NDLS (HR:MIN)
(IMPERIAL)**

Altitude (feet)	0 to 3000	3001 to 4000	4001 to 5000	5001 to 6000	6001 to 7000	7001 to 8000	8001 to 9000	9001 to 10000	10001 to 11000	11001 to 12000	12001 to 13000	13001 to 14000
Depth (FT)												
30	3:17	2:30	2:21	2:14	2:08	2:02	1:57	1:52	1:47	1:39	1:34	1:29
40	1:49	1:21	1:15	1:11	1:08	1:05	1:02	1:00	0:57	0:55	0:53	0:51
50	1:05	0:53	0:51	0:49	0:47	0:44	0:42	0:39	0:37	0:35	0:34	0:33
60	0:48	0:37	0:35	0:33	0:32	0:30	0:28	0:26	0:24	0:23	0:22	0:21
70	0:35	0:26	0:24	0:23	0:21	0:20	0:19	0:18	0:17	0:16	0:16	0:14
80	0:26	0:19	0:18	0:17	0:16	0:15	0:14	0:13	0:12	0:11	0:11	0:10
90	0:19	0:15	0:14	0:13	0:12	0:11	0:10	0:10	0:09	0:09	0:08	0:08
100	0:16	0:11	0:10	0:10	0:09	0:09	0:08	0:08	0:07	0:07	0:07	0:07
110	0:12	0:09	0:08	0:08	0:08	0:07	0:07	0:07	0:06	0:06	0:06	0:05
120	0:10	0:08	0:07	0:07	0:07	0:06	0:06	0:06	0:05	0:05	0:05	0:05
130	0:08	0:07	0:06	0:06	0:06	0:05	0:05	0:05	0:05	0:05	0:04	0:04
140	0:07	0:06	0:05	0:05	0:05	0:05	0:05	0:04	0:04	0:04	0:04	0:04
150	0:06	0:05	0:05	0:05	0:05	0:04	0:04	0:04	0:04	0:04	0:04	0:03
160	0:06	0:05	0:05	0:04	0:04	0:04	0:04	0:04	0:04	0:03	0:03	0:03
170	0:05	0:04	0:04	0:04	0:04	0:04	0:03	0:03	0:03	0:03	0:03	0:03
180	0:05	0:04	0:04	0:04	0:03	0:03	0:03	0:03	0:03	0:03	0:03	0:03
190	0:04	0:04	0:04	0:03	0:03	0:03	0:03	0:03	0:03	0:03	0:03	0:00

**Z+ BASED NDLS (HR:MIN)
(METRIC)**

Altitude (meters)	0 to 915	916 to 1220	1221 to 1525	1526 to 1830	1831 to 2135	2136 to 2440	2441 to 2745	2746 to 3050	3051 to 3355	3356 to 3660	3661 to 3965	3966 to 4270
Depth (M)												
9	3:37	2:41	2:31	2:23	2:16	2:10	2:04	1:59	1:54	1:50	1:43	1:37
12	1:55	1:27	1:21	1:15	1:12	1:08	1:05	1:03	1:00	0:58	0:55	0:54
15	1:08	0:55	0:53	0:51	0:49	0:47	0:44	0:42	0:39	0:37	0:36	0:34
18	0:50	0:39	0:37	0:35	0:33	0:32	0:30	0:28	0:26	0:24	0:23	0:22
21	0:36	0:28	0:26	0:24	0:23	0:21	0:20	0:19	0:18	0:17	0:16	0:16
24	0:27	0:20	0:19	0:18	0:17	0:16	0:15	0:14	0:13	0:12	0:11	0:11
27	0:20	0:16	0:15	0:13	0:12	0:11	0:11	0:10	0:09	0:09	0:09	0:08
30	0:16	0:12	0:11	0:10	0:09	0:09	0:09	0:08	0:08	0:07	0:07	0:07
33	0:13	0:09	0:09	0:08	0:08	0:07	0:07	0:07	0:07	0:06	0:06	0:06
36	0:10	0:08	0:07	0:07	0:07	0:06	0:06	0:06	0:05	0:05	0:05	0:05
39	0:09	0:07	0:06	0:06	0:06	0:06	0:05	0:05	0:05	0:05	0:05	0:04
42	0:08	0:06	0:06	0:05	0:05	0:05	0:05	0:05	0:04	0:04	0:04	0:04
45	0:06	0:05	0:05	0:05	0:05	0:04	0:04	0:04	0:04	0:04	0:04	0:04
48	0:06	0:05	0:05	0:04	0:04	0:04	0:04	0:04	0:04	0:03	0:03	0:03
51	0:05	0:04	0:04	0:04	0:04	0:04	0:04	0:03	0:03	0:03	0:03	0:03
54	0:05	0:04	0:04	0:04	0:04	0:03	0:03	0:03	0:03	0:03	0:03	0:03
57	0:05	0:04	0:04	0:03	0:03	0:03	0:03	0:03	0:03	0:03	0:03	0:03

ADDITIONAL INFORMATION PERTAINING TO BRIGHTNESS & POWER CONSUMPTION

As indicated in various sections of this manual, there are numerous factors that affect battery consumption. Some can reduce battery use life quite rapidly such as keeping the Brightness level set at 100% and not taking advantage of the Auto Dim feature to conserve power when the screen is not being viewed during dives.

Note that Auto Dim settings are entered only when on the surface and cannot be changed once a dive is started.

Remember also that a press/release of the S (side) button will restore the Dive Main screen from the Auto Dim level to the Brightness level you adjusted it to.

The chart below provides approximate Hours of Operation that can be expected for a new battery before it displays a Low Battery Warning condition (BATT icon is green until it turns yellow).

- > As indicated by the chart, the hours will vary depending on different combinations of Brightness levels that you might use together with Auto Dim settings that you may chose to consider using for activities to be conducted.
- > Testing indicates that once the Low Battery icon comes on yellow, indicating a low battery warning condition, operations may continue for 3 hours with the Brightness held at 60% maximum.

It may not be possible to keep track of the time that has transpired once the icon color changes and a low battery alarm condition could appear unexpectedly.

Brightness Level (adjustment)	Dim To Level (% set)	Time To Dim (min:sec set)	Hours of Normal Operation Expected (BATT icon green)
100	na	Off	15
100	50	0:20	20
100	10	0:20	30
100	50	2:00	19
100	10	2:00	24
80	na	Off	18
80	40	0:20	24
80	10	0:20	32
80	40	2:00	22
80	10	2:00	26
60	na	Off	21
60	30	0:20	27
60	10	0:20	34
60	30	2:00	25
60	10	2:00	30
50	na	Off	24
50	30	0:20	28
50	10	0:20	35
40	40	0:20	26
40	20	0:20	35
30	na	Off	30
30	10	0:20	38
30	10	1:00	33
10	na	Off	42

INSPECTION / SERVICE RECORD

VTX Serial Number: _____

VTX Firmware Rev: _____

Transmitter 1 Serial Number: _____

Transmitter 2 Serial Number: _____

Transmitter 3 Serial Number: _____

Transmitter 4 Serial Number: _____

Date of Purchase: _____

Purchased from: _____

Below to be filled in by an Authorized Oceanic Dealer:

Date	Service Performed	Dealer/Technician

Oceanic WORLD WIDE

Oceanic USA
 2002 Davis Street
 San Leandro, CA 94577
 Tel: 510/562-0500
 Fax: 510/569-5404
 Web: www.OceanicWorldwide.com
 E-mail: hello@Oceanicusa.com

Oceanic EUROPE
 Augsburg, Germany
 Tel: +49 (0) 821 810342 0 Fax: +49 (0) 821 810342 29
 Web: www.Oceanic-eu.com
 E-mail: office@Oceanic.de

Oceanic ASIA PACIFIC
 Singapore
 Tel: +65-6391-1420 Fax: +65-6297-5424
 E-mail: info@Oceanicasia.com.sg

Oceanic UK
 Devon, United Kingdom
 Tel: (44) 1404-891819 Fax: +44 (0) 1404-891909
 Web: www.OceanicUK.com
 E-mail: helpyou@Oceanicuk.com

Oceanic HAWAII and MICRONESIA
 Kapolei, Hawaii
 Tel: 808-682-5488 Fax: 808-682-1068
 E-mail: lbell@Oceanicusa.com

Oceanic AUSTRALIA
 Rosebud, Victoria, Australia
 Tel: 61-3-5986-0100 Fax: 61-3-5986-1760
 Web: www.OceanicAUS.com.au
 E-mail: sales@OceanicAUS.com.au

VTX

DIVE COMPUTER

OPERATING MANUAL